



**airFiber™**

24 GHz Point to Point  
1.4+ Gbps Radio

Model: AF24

USER GUIDE

## Table of Contents

---

<b>Chapter 1: Overview</b> .....	1
Introduction .....	1
Package Contents .....	1
airFiber Configuration Interface System Requirements .....	1
Hardware Overview .....	1
<b>Chapter 2: Installation</b> .....	3
Link Planning .....	3
Installation Requirements .....	4
Installation Instructions .....	4
Connecting Power over Ethernet .....	4
airFiber Configuration .....	5
Hardware Installation .....	6
Connecting Ethernet .....	8
Alignment .....	9
<b>Chapter 3: Navigation</b> .....	14
Accessing the airFiber Configuration Interface .....	14
Product Verification .....	15
Interface Tabs .....	15
<b>Chapter 4: Main Tab</b> .....	16
Status .....	16
Monitor .....	17
<b>Chapter 5: Wireless Tab</b> .....	18
Basic Wireless Settings .....	19
Wireless Security .....	19
<b>Chapter 6: Network Tab</b> .....	20
Management Network Settings .....	20
<b>Chapter 7: Advanced Tab</b> .....	22
Advanced Wireless Settings .....	22
Advanced Ethernet Settings .....	22
<b>Chapter 8: Services Tab</b> .....	23
Ping Watchdog .....	23
SNMP Agent .....	24
Telnet Server .....	25
NTP Client .....	25
Dynamic DNS .....	25
System Log .....	25
Device Discovery .....	26

<b>Chapter 9: System Tab</b> .....	27
Firmware Update.....	27
Device .....	28
Date Settings.....	28
System Accounts .....	28
Miscellaneous .....	29
Location .....	29
Device Maintenance.....	29
Configuration Management .....	29
<b>Chapter 10: Tools</b> .....	30
Align Antenna.....	30
Discovery .....	31
Ping.....	31
Traceroute .....	31
RX Speed Test .....	31
<b>Appendix A: Specifications</b> .....	32
<b>Appendix B: Safety Notices</b> .....	34
Electrical Safety Information .....	34
<b>Appendix C: Warranty</b> .....	35
General Warranty.....	35
<b>Appendix D: Compliance Information</b> .....	36
Installer Compliance Responsibility .....	36
FCC .....	36
Industry Canada.....	36
RF Exposure Warning .....	36
CE Marking.....	36
RoHS/WEEE Compliance Statement.....	37
<b>Appendix E: Declaration of Conformity</b> .....	38
<b>Appendix F: Contact Information</b> .....	39
Ubiquiti Networks Support .....	39

# Chapter 1: Overview

## Introduction

Thank you for purchasing the airFiber AF24. Our product is purpose-built to create a high-performance backhaul. airFiber AF24 provides revolutionary features, including:

- RF interface with 24 GHz, 100 MHz wide channels and up to 1.4 Gbps, aggregate throughput (in full-duplex mode)
- Split-antenna architecture

## Package Contents

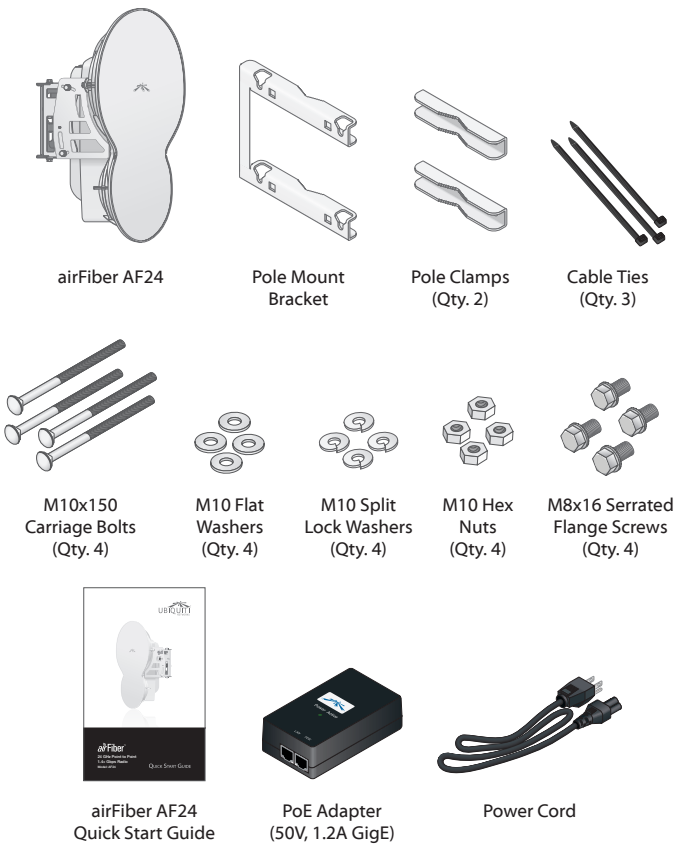

## Hardware Overview

### Side

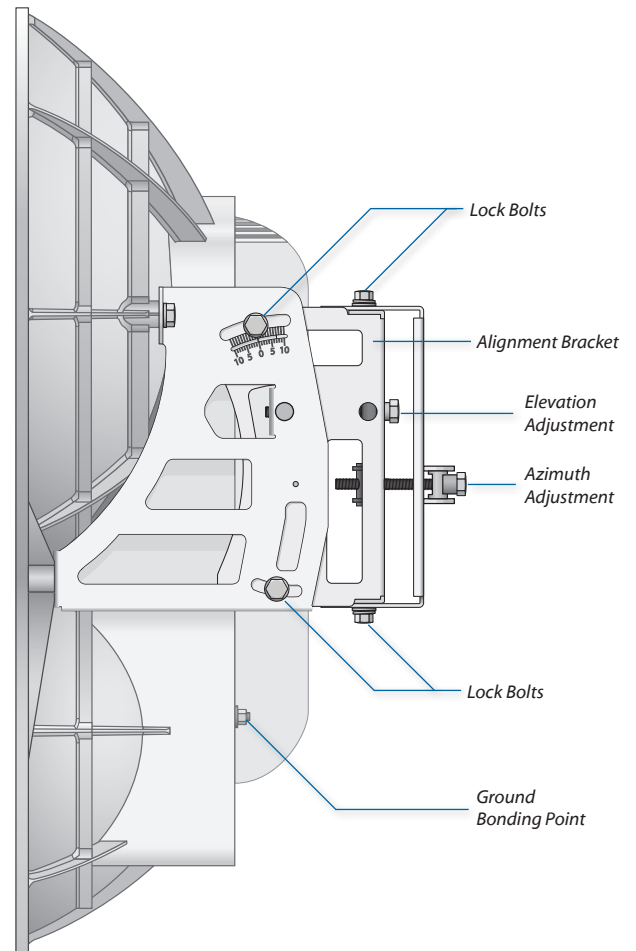

## airFiber Configuration Interface System Requirements

- Microsoft Windows XP, Windows Vista, Windows 7, Linux, or Mac OS X
- Java Runtime Environment 1.6 (or above)
- Web Browser: Mozilla Firefox, Apple Safari, Google Chrome, or Microsoft Internet Explorer 8 (or above)



## Back

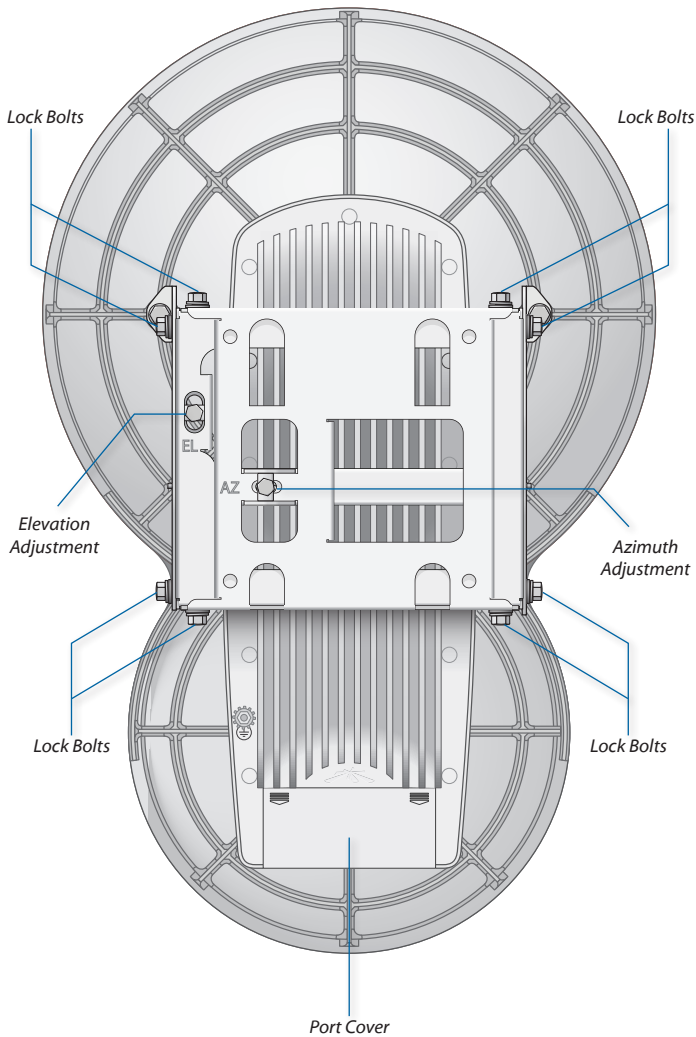

## Interfaces

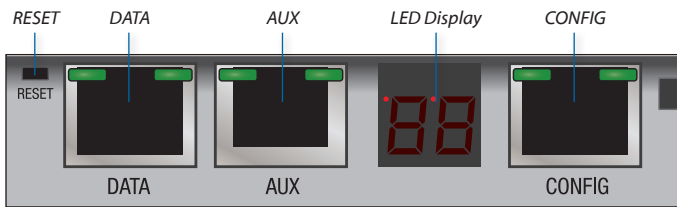

Interface	Description
RESET	To reset to factory defaults, press and hold the RESET button for more than five seconds while the unit is already powered on.
DATA	10/100/1000 Mbps port handles all user traffic.
AUX	Port for audio tone aiming. See <b>"Aiming Using the Audio Tone"</b> on page 12 for more details.
LED Display	Digital display used for power, status, and mode information.
CONFIG	10/100 Mbps, secured port for configuration. By default, this is the only port that can monitor, configure, and/or update firmware.

## LEDs

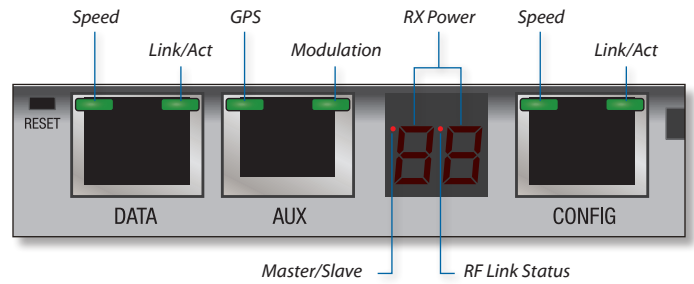

LED	State	Status		
DATA	Speed	Off	10/100 Mbps	
		On	1000 Mbps	
	Link/Act	Off	No Ethernet Link	
		On	Ethernet Link Established	
		Random Flashing	Ethernet Activity	
AUX	GPS	Off	No GPS Synchronization	
		On	Operational (Strong Signal)	
			Normal Flash*	Operational (Weak Signal)
	Modulation	Off	1x (QPSK SISO)	
		Short Flash*	2x (QPSK MIMO)	
		Normal Flash*	4x (16QAM MIMO)	
		Long Flash*	6x (64QAM MIMO)	
LED Display	RX Power (-dBm)	Number	Strong RX Signal	
		Flashing Number	Weak RX Signal	
			□ L	Overload Condition
	Master/Slave	Off	Slave Mode	
		On	Master Mode	
	RF Link Status	Off	RF Off	
		Short Flash*	Syncing	
		Normal Flash*	Beaconing	
Long Flash*		Registering		
On		Operational		
CONFIG	Speed	Off	10 Mbps	
		On	100 Mbps	
	Link/Act	Off	No Ethernet Link	
		On	Ethernet Link Established	
		Random Flashing	Ethernet Activity	

<sup>1</sup> Short Flash (1:3 on/off cycle)  
 Normal Flash (1:1 on/off cycle)  
 Long Flash (3:1 on/off cycle)

## Chapter 2: Installation

### Link Planning

Before you install the airFiber AF24, there are a few items to consider:

- Humidity and rain
- Point-to-Point (PtP), daisy chain, or ring configuration
- Co-Location

### Humidity and Rain

Consider the impact of humidity and rain on your link. Radio waves in the 24 GHz band encounter additional atmospheric attenuation beyond that which is expected in free space due to water absorption, including rain fade. A general guideline is an additional loss of 1 to 3 dB per kilometer. The amount of additional atmospheric attenuation will vary, depending on your specific installation environment (the world has a variety of rainfall zones).

Here is a hypothetical example: if your link is exposed to a 25 mm/hr rate of rainfall, it may have an additional loss of up to 4 dB/km. The table below illustrates the estimated additional attenuation at various rainfall rates and distances. This information was derived from [FCC Office of Engineering and Technology Bulletin #70](#).

Estimated Additional Attenuation at Various Rain Rates and Distances

Distance	1.25 mm/hr	5 mm/hr	25 mm/hr
1 km	0.2 dB	0.7 dB	4 dB
2 km	0.4 dB	1.4 dB	8 dB
3 km	0.6 dB	2.1 dB	12 dB
4 km	0.8 dB	2.8 dB	16 dB
5 km	1 dB	3.5 dB	20 dB

There are a variety of software programs available to help calculate rain attenuation. For more information about rain attenuation and rainfall zones, here are a couple of resources:

- The rain attenuation model described in ITU-R Recommendation P.530, *Propagation data and prediction methods required for the design of terrestrial line-of-sight systems*, which is available at: [www.itu.int/rec/R-REC-P.530/en](http://www.itu.int/rec/R-REC-P.530/en)
- The rainfall zones described in ITU-R Recommendation P.837, *Characteristics of precipitation for propagation modelling*, which is available at: <http://www.itu.int/rec/R-REC-P.837-5-200708-1/en>

### Configuration

There are three typical configurations:

- **PtP backhaul** Uses two airFiber radios, one configured as *Master* and the other configured as *Slave*.



- **Daisy chain** Uses multiple airFiber radios to extend the distance of a link, like a relay from point to point to point. The airFiber radios in the same node must use the same *Wireless Mode (Master or Slave)*.

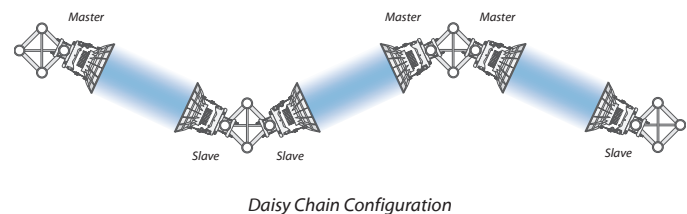

- **Ring** Uses multiple airFiber radios to form redundant paths. If one link goes down, the other links have an alternate route available. For each link, configure one airFiber radio as *Master*, and configure the other as *Slave*.

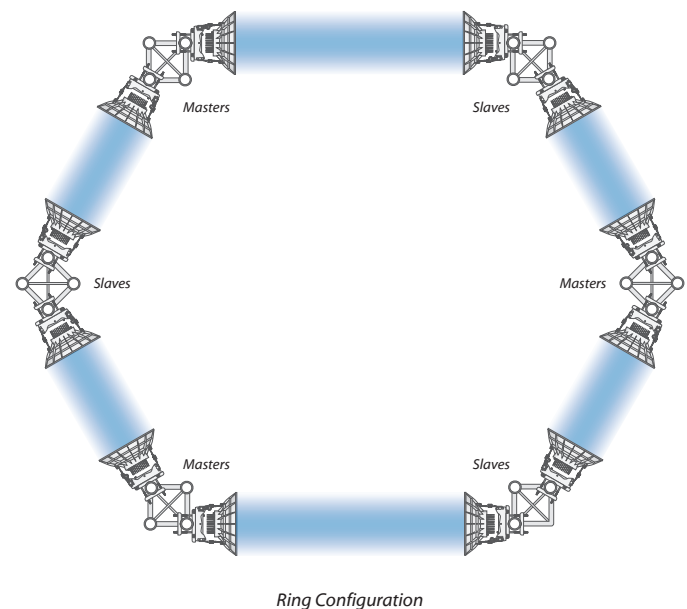

### Co-Location

In most cases, co-location interference is not a concern because the beamwidth is narrow. You can co-locate multiple airFiber radios if they are pointed in different directions. Co-located airFiber radios must use the same *Wireless Mode (Master or Slave)*. Back-to-back airFiber radios can use the same frequency. We recommend that you use different frequencies for adjacent airFiber radios; however, this is not a strict requirement.

## Installation Requirements

- 17 mm wrench
- 13 mm socket wrench or driver
- Clear line of sight between airFiber radios
- Clear view of the sky for proper GPS operation
- Mounting location with < 0.5 degree displacement due to twist and sway under wind loading
- Mounting point:
  - At least 1 meter below the highest point on the structure
  - For tower installations, at least 3 meters below the top of the tower
- Ground wire - min. 8 AWG (8.37mm<sup>2</sup>), max. length: 1 meter
- (Recommended) 2 Outdoor Gigabit PoE surge protectors



**Note:** For guidelines about grounding and lightning protection, follow your local National Electrical Code (NEC) standards.

- Outdoor, shielded Category 5e (or above) cabling should be used for all wired Ethernet connections. Category 6 is required for installations with long cable runs (up to 100 m).

We recommend that you protect your networks from the most brutal environments and devastating ESD attacks with industrial-grade shielded Ethernet cable from Ubiquiti Networks. For more details, visit

[www.ubnt.com/toughcable](http://www.ubnt.com/toughcable)

## Installation Instructions

We recommend that you configure your paired airFiber radios before mounting. To configure device settings in the airFiber Configuration Interface, you will need to connect Power over Ethernet to the *DATA* port and connect an Ethernet cable between your computer and the *CONFIG* port. Once you have completed configuration, disconnect the cables to move the airFiber radios, and then reconnect at the site. After you have mounted the airFiber radios, then you can establish and optimize the RF link.

## Connecting Power over Ethernet

1. Press down on the indicator arrows and slide the *Port Cover* off.

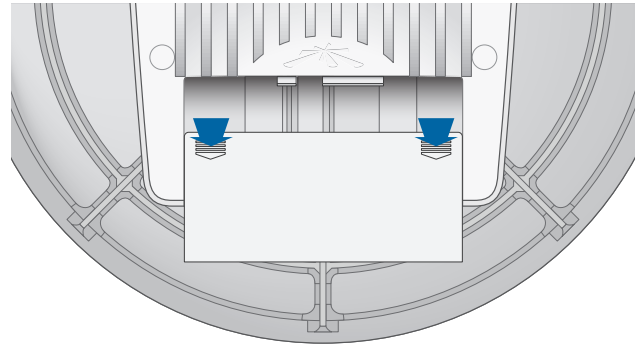

2. Connect an Ethernet cable to the *DATA* port.

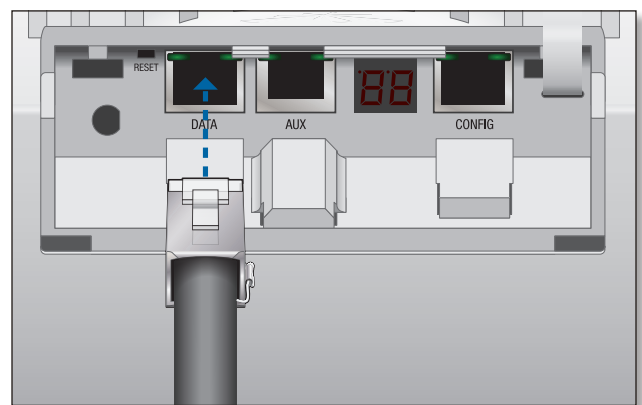

3. Connect the other end of the Ethernet cable from the *DATA* port to the Ethernet port labeled **POE** on the *PoE Adapter*.

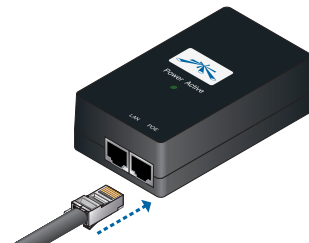

4. Connect the *Power Cord* to the power port on the *PoE Adapter*. Connect the other end of the *Power Cord* to a power source.

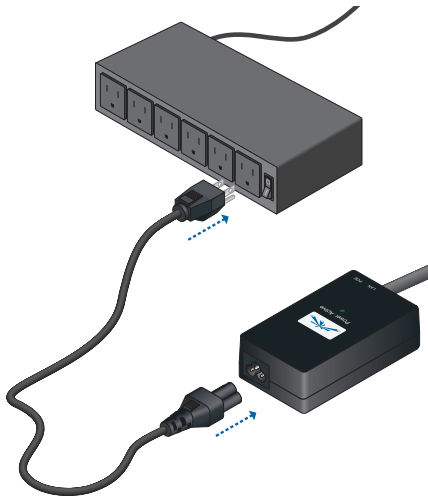

## airFiber Configuration

The instructions in this section explain how to access the airFiber Configuration Interface and configure the following settings:

- **Wireless Mode** Configure one airFiber AF24 as the *Master* and the other as the *Slave*.
- **Duplex** The airFiber AF24 supports both half-duplex and full-duplex operation. Half-duplex operation provides more frequency planning options at the cost of higher latency and throughput. Full-duplex operation provides the highest throughput and lowest latency; however, you have fewer frequency management options.

- **Half Duplex (default)** The *TX* and *RX* Frequencies are the same.

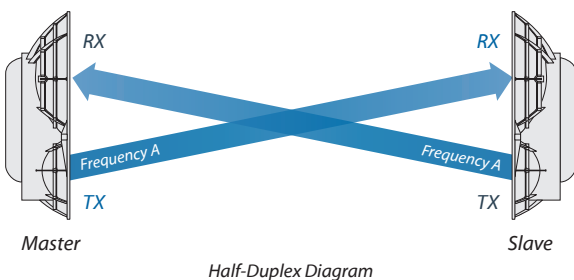

- **Full Duplex** The *TX* and *RX* Frequencies must be different.

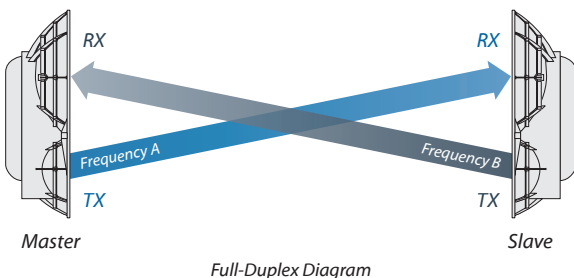

- **TX and RX Frequencies** The *TX* Frequency on the Master must match the *RX* Frequency on the Slave, and vice versa.

1. Connect an Ethernet cable from your computer to the *CONFIG* port on the airFiber AF24.

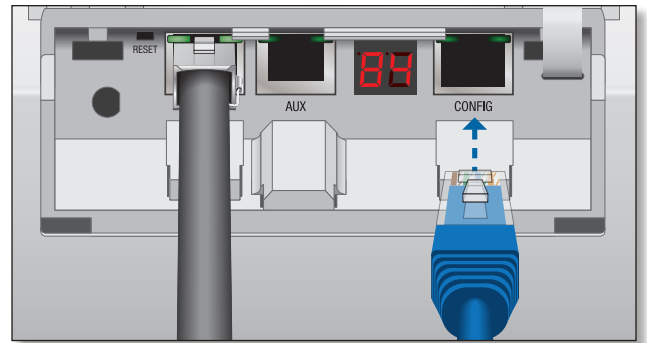

2. Configure the Ethernet adapter on your computer with a static IP address on the 192.168.1.x subnet (e.g., 192.168.1.100).
3. Launch your Web browser. Type **http://192.168.1.20** in the address field and press **enter** (PC) or **return** (Mac).



4. The login screen will appear. Enter **ubnt** in the *Username* and *Password* fields. Select your *Country* and *Language*. You must agree to the *Terms of Use* to use the product. Click **Login**.

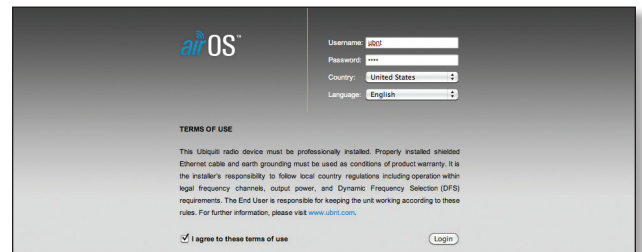

**Note:** U.S. product versions are locked to the U.S. Country Code to ensure compliance with FCC regulations.

5. Click the **Wireless** tab.

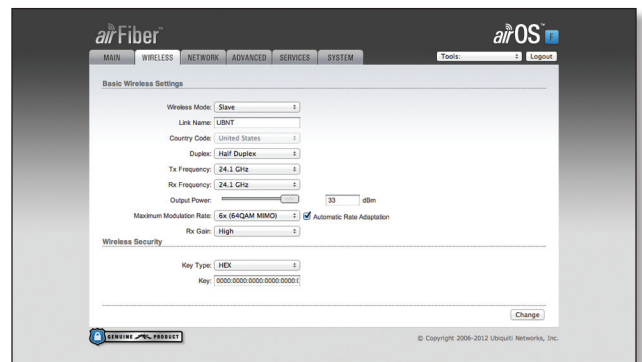

6. Enter the *Basic Wireless Settings*.
  - a. For one airFiber AF24, select **Master** from the *Wireless Mode* drop-down. For the other airFiber AF24, keep the default, *Slave*.
  - b. Enter a name in the *Link Name* field. This should be the same on both the Master and the Slave.
  - c. For the *Duplex* drop-down:
    - **Half Duplex** The default mode. The *TX* and *RX Frequencies* are the same.
    - **Full Duplex** The *TX* and *RX Frequencies* must be different.
  - d. Select a *TX Frequency*. This must match the *RX Frequency* on your other airFiber AF24.
  - e. Select a *RX Frequency*. This must match the *TX Frequency* of your other airFiber AF24.
  - f. If needed, change the *Output Power*, *Maximum Modulation Rate*, and/or *RX Gain* settings.
7. Configure the *Wireless Security*:
  - a. Select the *AES Key Type*, **HEX** or **ASCII**.
  - b. For the *Key* field:
    - **HEX** Enter 16 bytes (eight, 16-bit HEX values: 0-9, A-F, or a-f). You can omit zeroes and use colons, similar to the IPv6 format. The default is as follows:  
**0000:0000:0000:0000:0000:0000:0000:0000**.
8. Click **Change** and then click **Apply**.
9. By default, in-band management is disabled. To enable in-band management:
  - a. Click the **Network** tab.

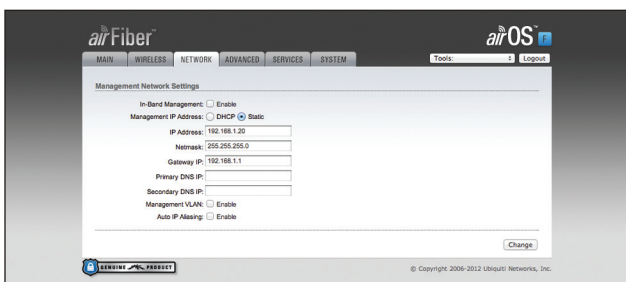

- b. Select **Enable In-Band Management**.
- c. You can change the IP Address, Netmask, and other settings to make them compatible with your network.

 **Note:** If *In-Band Management* is enabled, each airFiber radio must have a unique *IP Address*. If the airFiber radios use the same *IP Address*, then you may lose access to the airFiber radios via the *CONFIG* and *DATA* ports.

- d. Click **Change** and then click **Apply**.

Repeat the instructions in the *airFiber Configuration* section on your other airFiber radio. After you have configured the airFiber radios, disconnect them and move them to your installation site.

## Hardware Installation

To install the airFiber AF24:

1. Insert the four *M10x150 Carriage Bolts* into the *Pole Mount Bracket*.

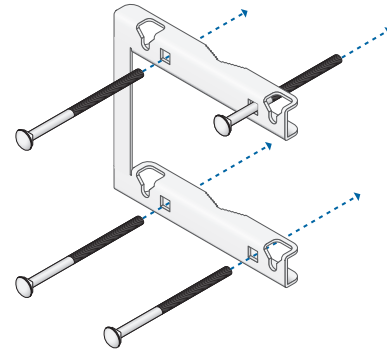

2. Attach the *Pole Mount Bracket* to a pole. Orient the *Pole Mount Bracket* so it is aimed in the direction of the other airFiber AF24. Slip the *Pole Clamps* onto the *M10x150 Carriage Bolts*. Secure the clamps with the *M10 Flat Washers*, *Split Lock Washers*, and *Hex Nuts*.

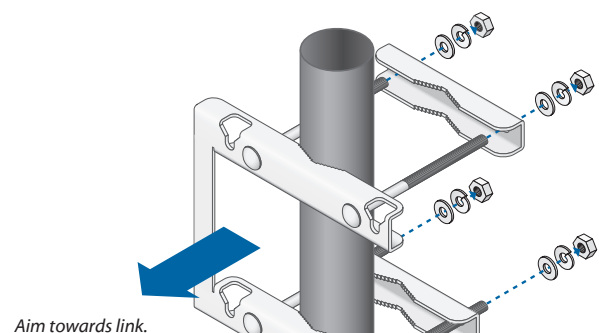



- Secure the four *M8x16 Serrated Flange Screws* to the back of the *Alignment Bracket*. Do not completely tighten the screws; leave a 6 mm gap between the screw head and the bracket.

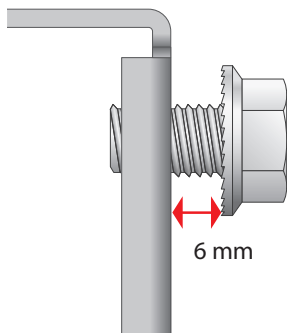
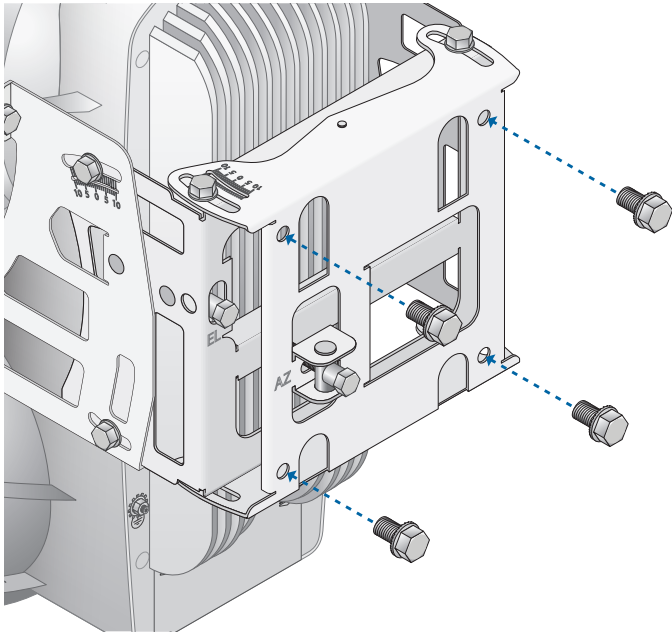

- Lift the airFiber and align the four *M8x16 Serrated Flange Screws* with the slots on the *Pole Mount Bracket*. Seat the screws into the slots. Securely tighten the screws.

**WARNING:** To prevent injury, ensure that all four screws are seated and fully tightened.

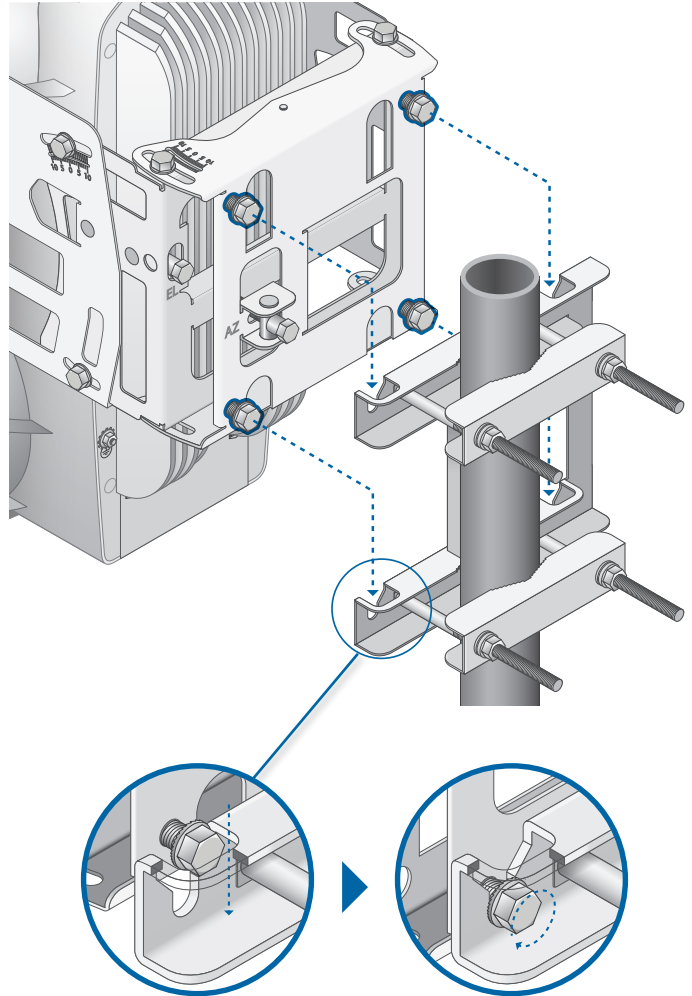

5. Attach a ground wire by performing the following steps:

a. Remove the nut from the *Ground Bonding Point*.

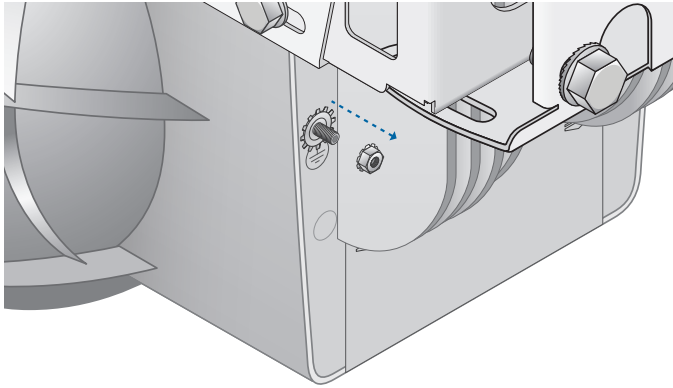

b. Attach a ground wire (min. 8 AWG or 10 mm<sup>2</sup>) to the lug and replace the nut to secure the wire.

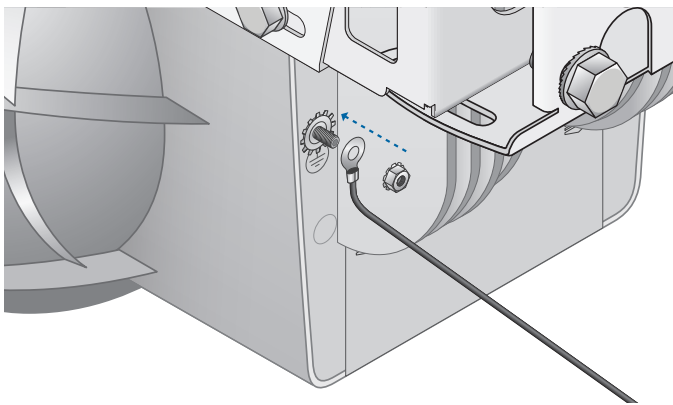

c. Secure the other end of the ground wire to the pole, tower, or grounding bar.



**Note:** The grounding wire should be as short as possible and no longer than 1 meter in length.

## Connecting Ethernet

1. Press down on the indicator arrows and slide the *Port Cover* off.

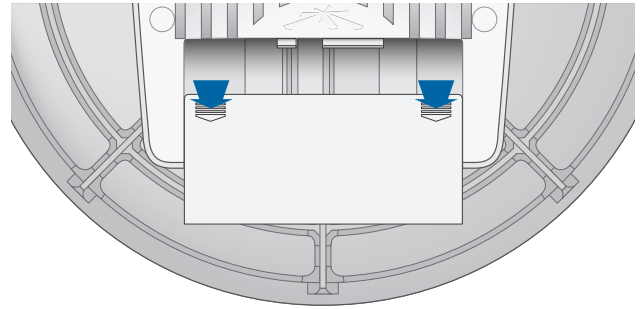

2. Connect a TOUGH Cable or other outdoor, shielded CAT5e/6 cable to the *DATA* port.

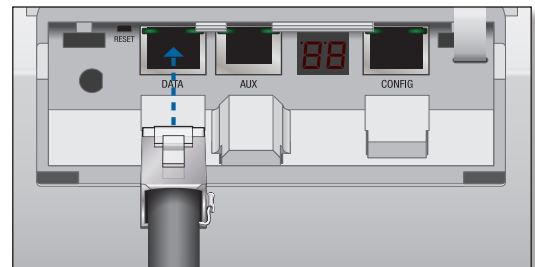

3. Create a strain relief for the Ethernet cable by feeding a cable tie through the tie slot under the cable. Then wrap the cable tie around the cable and tighten.

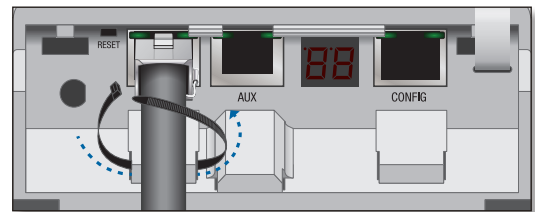

4. Connect the other end of the Ethernet cable from the *DATA* port to the Ethernet port labeled **POE** on the *PoE Adapter*.

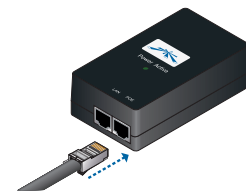

5. Connect an Ethernet cable from your LAN to the Ethernet port labeled **LAN** on the *PoE Adapter*.

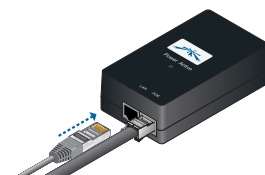

6. Connect the *Power Cord* to the power port on the *PoE Adapter*. Connect the other end of the *Power Cord* to a power source.

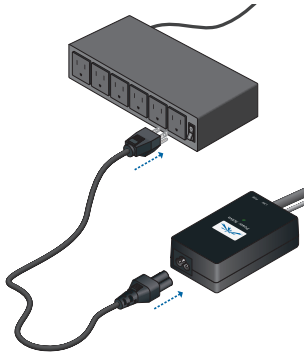

**Note:** For added protection, we recommend installing two GigE PoE surge protectors. Install the first surge protector within one meter of the airFiber *DATA* port, and install the second surge protector at the ingress point of the location housing the wired network equipment.

Below is a diagram of a finished installation with recommended surge protectors installed.

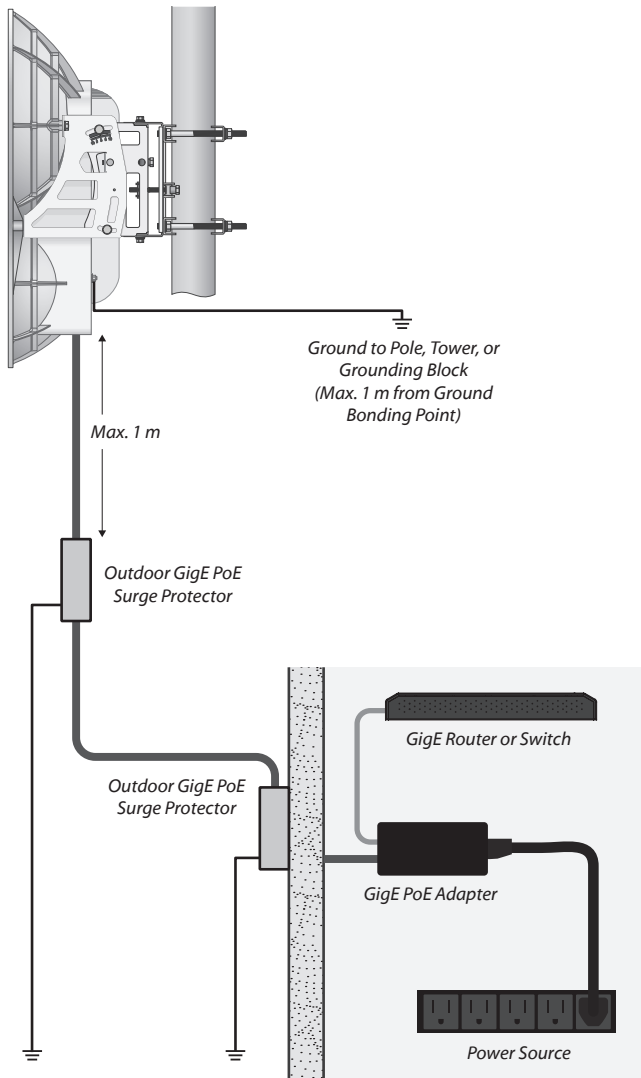

## Alignment

To align the airFiber radios for best performance, you **MUST** align only one end of the link at a time. Begin the alignment process with the *Slave* first.

There are three methods for fine-tuning the alignment:

- LED Display (See below.)
- airFiber Configuration Interface (See **"Aiming Using the airFiber Configuration Interface" on page 10.**)
- audio tone (Optional equipment required. See **"Aiming Using the Audio Tone" on page 12.**)

### Aiming Using the LED Display

1. Loosen, but **DO NOT** remove the eight *Lock Bolts* located on the *Alignment Bracket*.

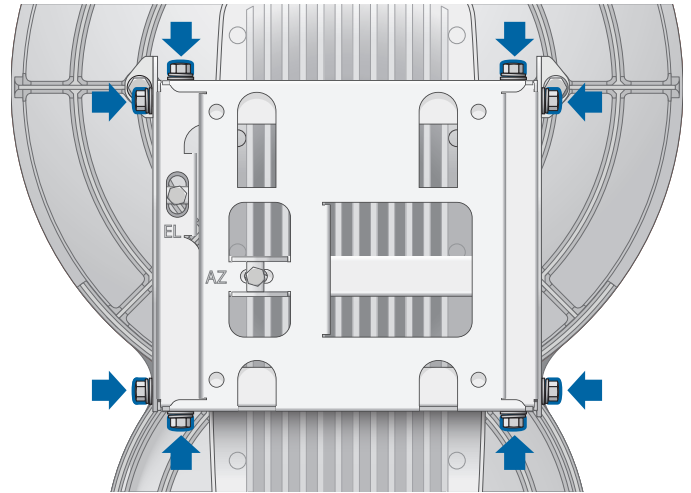



- While adjusting the azimuth, observe the numeric LED Display located next to the *CONFIG* port. The values are displayed in negative (-) dBm. Adjust the azimuth for the strongest received signal level. For example, a displayed value of 42 represents a received signal level of -42 dBm, which is a stronger received signal than 47, which represents -47 dBm.

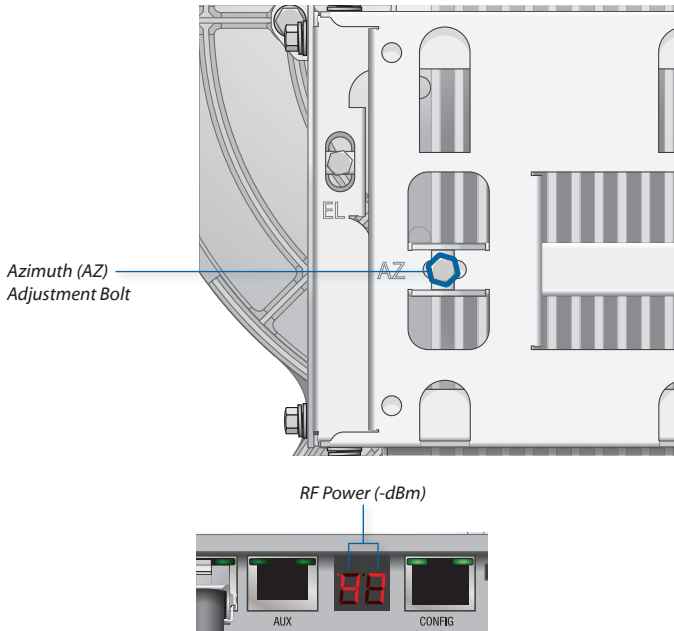

**Note:** If the LED Displays indicates an overload condition **63**,

- Observe the LED Display and adjust the elevation until the strongest received signal level is displayed.

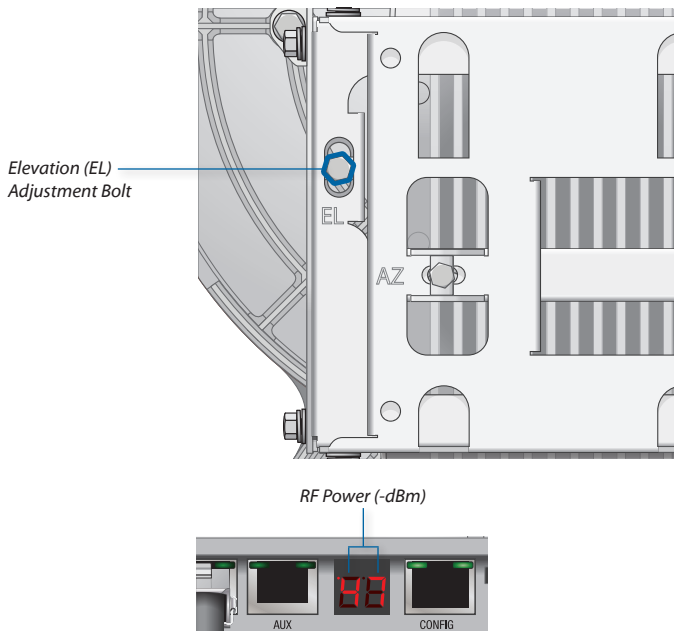

- Repeat steps 1-3 for the *Master*.
- On the *Slave*, repeat steps 2-3 to finalize the alignment.
- On the *Master*, repeat steps 2-3 to finalize the alignment.
- Lock the alignment on both airFiber radios by tightening all eight *Lock Bolts* on the *Alignment Bracket*.

Observe the LED Display on each airFiber AF24 to ensure that the value remains constant while tightening the *Lock Bolts*. If the LED value changes during the locking process, loosen the *Lock Bolts*, finalize the alignment of each airFiber AF24 again, and retighten the *Lock Bolts*.

### Aiming Using the airFiber Configuration Interface

- To access the airFiber Configuration Interface:
  - Make sure that your computer that is connected to the *CONFIG* port on the airFiber AF24.
  - Configure the Ethernet adapter on your computer with a static IP address on the 192.168.1.x subnet (for example, 192.168.1.100).
  - Launch your Web browser. Type **http://192.168.1.20** in the address field and press **enter** (PC) or **return** (Mac).



- Enter **ubnt** in the *Username* and *Password* fields, and click **Login**.

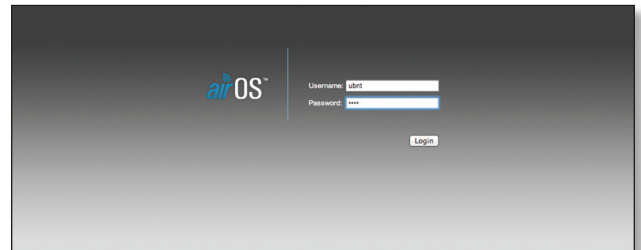

- The *Main* tab of the airFiber Configuration Interface appears. Click the **Tools** drop-down list at the top right corner of the page.
- Click **Align Antenna**. You will use the *Align Antenna* tool to point and optimize the antenna in the direction of maximum link signal. The *Antenna Alignment* window reloads every second. (See "**Align Antenna**" [on page 30](#) for more details.)
- The *Antenna Alignment* window appears.



- Loosen, but DO NOT remove the eight *Lock Bolts* located on the *Alignment Bracket*.

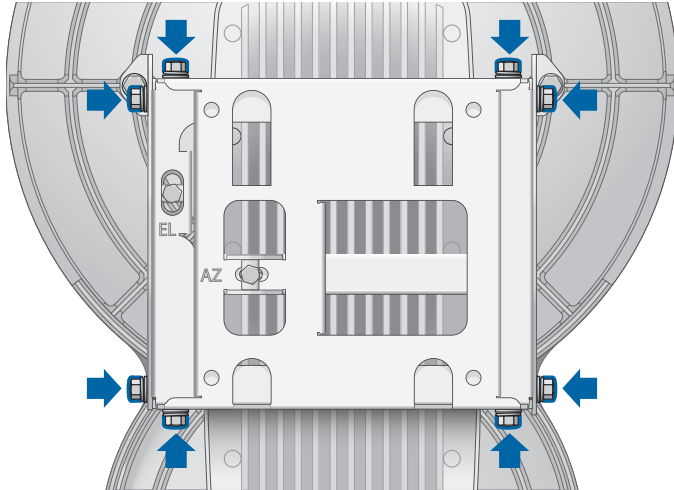

- While adjusting the azimuth, observe the *Antenna Alignment* window. The *Chain 0* and *Chain 1 Signal Strength* bar graphs display the absolute power level (in dBm) of the received signal for each chain. Adjust the azimuth for the strongest received *Signal Strengths*. For example, a displayed value of -42 dBm is a stronger received signal than -47 dBm.

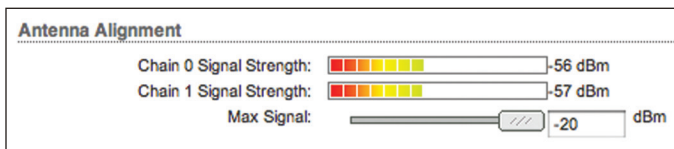
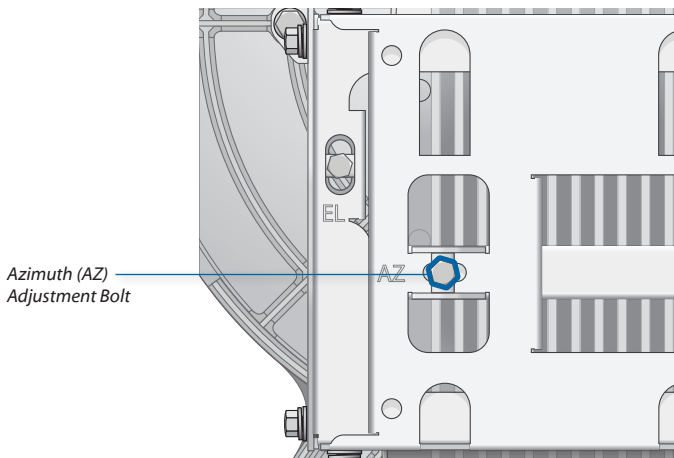

- Observe the *Antenna Alignment* window, and adjust the elevation until the *strongest Signal Strengths* are displayed.

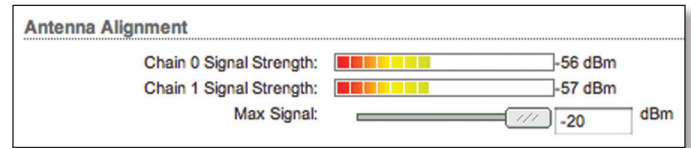
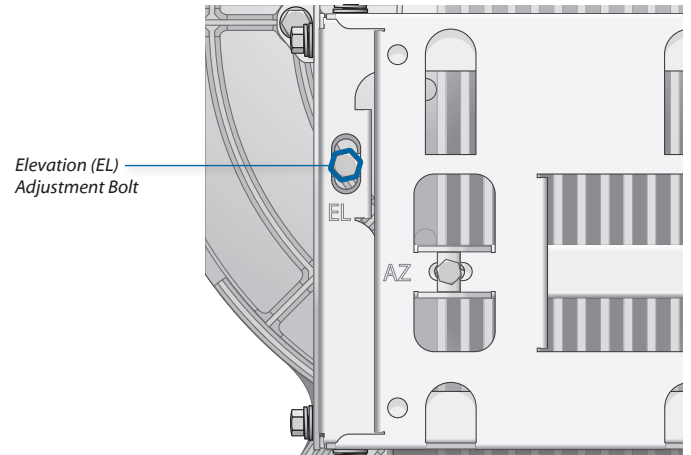

- Repeat steps 1-4 for the *Master*.
- On the *Slave*, repeat steps 3-4 to finalize the alignment.
- On the *Master*, repeat steps 3-4 to finalize the alignment.
- Lock the alignment on both airFiber radios by tightening all eight *Lock Bolts* on the *Alignment Bracket*.

Observe the *Antenna Alignment* window on each airFiber AF24 to ensure that the value remains constant when tightening the *Lock Bolts*. If the *Signal Levels* change during the locking process, loosen the *Lock Bolts*, finalize the alignment of each airFiber AF24 again, and retighten the *Lock Bolts*.

## Aiming Using the Audio Tone

### Before You Begin

Create your own cable adapter to connect the *AUX* port to your headphones or other listening device. The cable adapter requires two items:

- An RJ-12 cable with an RJ-12 connector
  - A cable with a 3.5 mm, female, stereo phono jack (mono jack is acceptable)
1. Attach the wire from pin 6 of the RJ-12 cable to the return or shield wire of the 3.5 mm jack.
  2. Attach the wire from pin 5 of the RJ-12 cable to both the left and right channel wires of the 3.5 mm stereo phono jack.



**Note:** For a mono jack, connect the wire from pin 5 to the + wire of the mono jack.

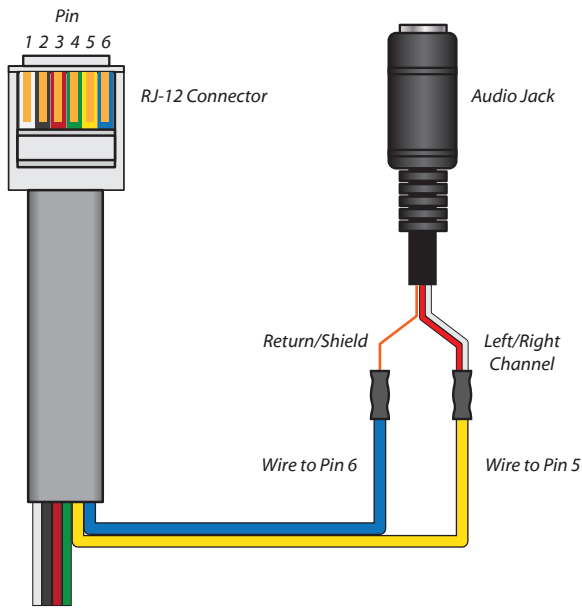

**Note:** Wire colors may vary on RJ-12 cables.

## Instructions

1. Loosen, but **DO NOT** remove the eight *Lock Bolts* located on the *Alignment Bracket*.

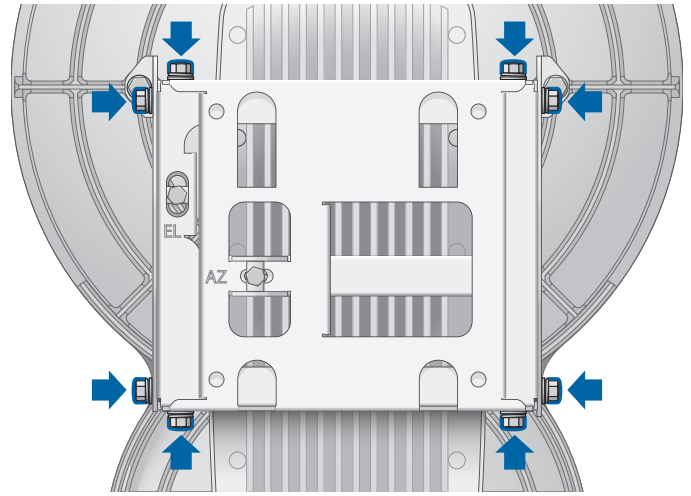

2. While adjusting the azimuth, listen to the audio tone—the higher the pitch, the *stronger* the signal strength. Adjust the azimuth for the strongest received signal level.

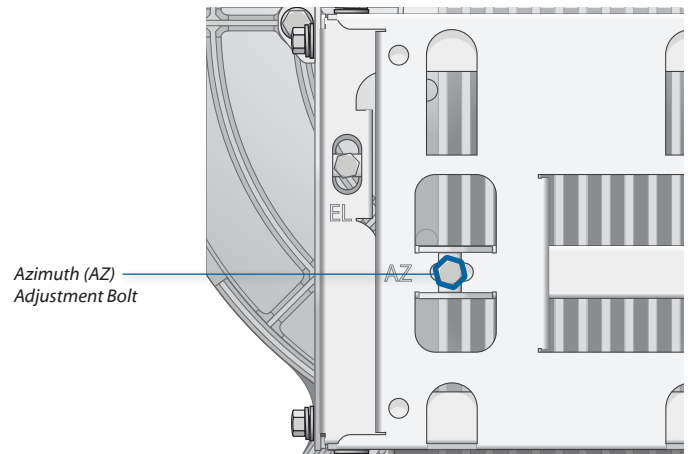

3. Listen to the audio tone, and adjust the elevation until the *highest* pitch is heard.

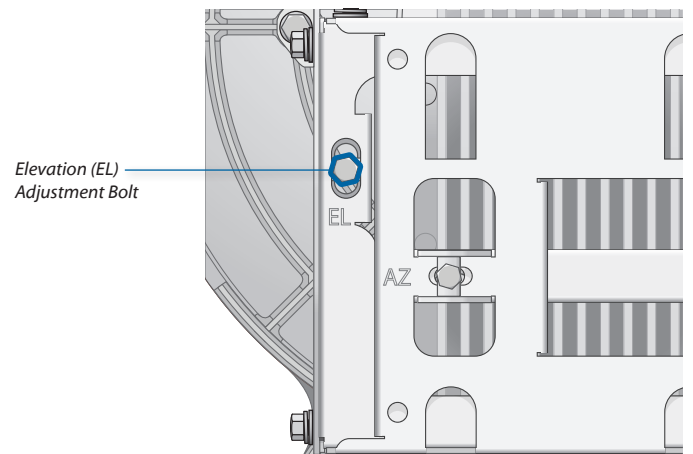

4. Repeat steps 1-3 for the *Master*.
5. On the *Slave*, repeat steps 2-3 to finalize the alignment.
6. On the *Master*, repeat steps 2-3 to finalize the alignment.
7. Lock the alignment on both airFiber radios by tightening all eight *Lock Bolts* on the *Alignment Bracket*.

Listen to the audio tone for each airFiber AF24 to ensure that the value remains constant when tightening the *Lock Bolts*. If the pitch changes during the locking process, loosen the *Lock Bolts*, finalize the alignment of each airFiber AF24 again, and retighten the *Lock Bolts*.

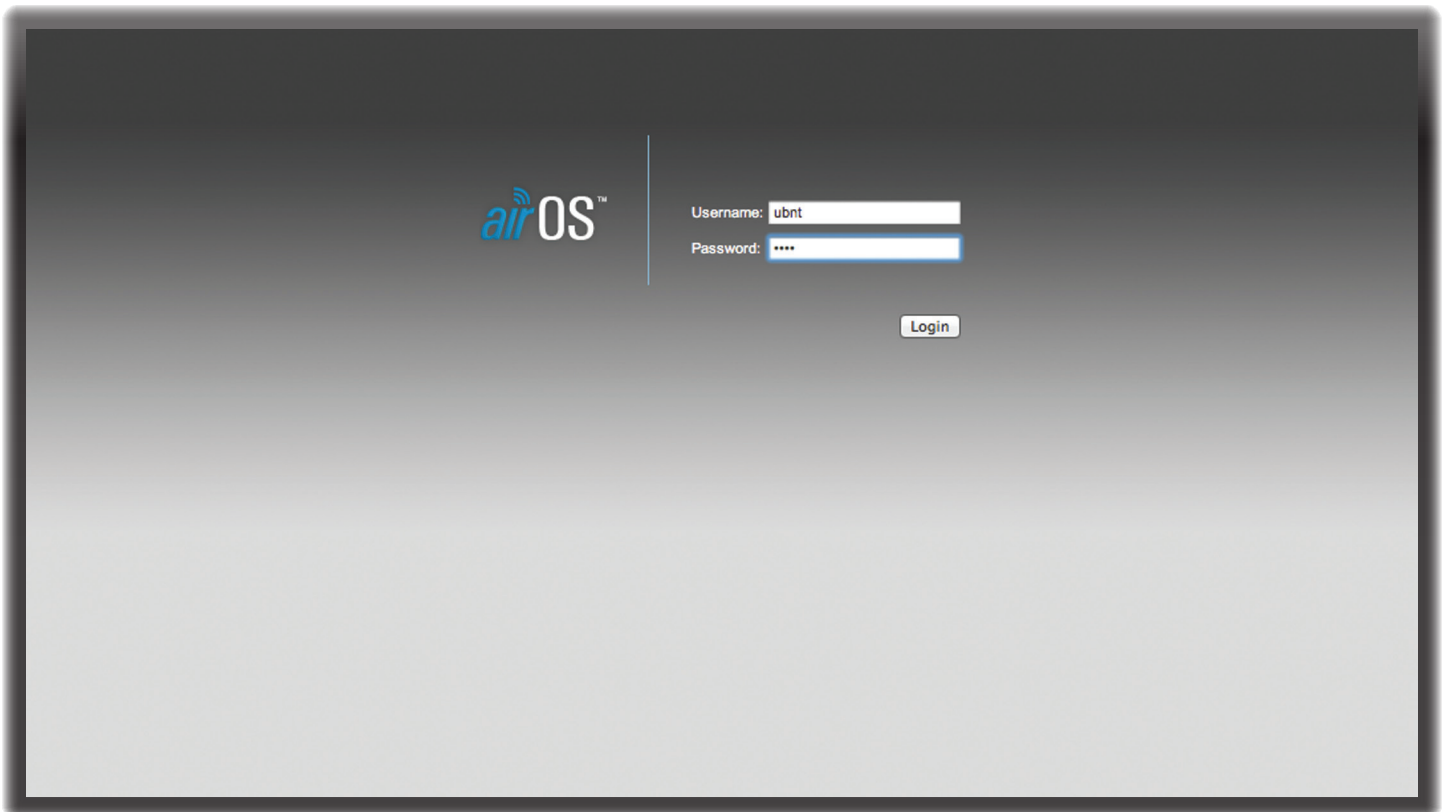

## Chapter 3: Navigation

The airFiber Configuration Interface is an advanced operating system capable of powerful wireless and routing features, built upon a simple and intuitive user interface foundation.

The airFiber AF24 uses the airFiber Configuration Interface for easy configuration and management via a Web browser.

There are two ways to access the airFiber Configuration Interface:

- **CONFIG Port** Enabled by default. Use a direct connection to the *CONFIG* port for out-of-band management.
- **In-Band Management** Disabled by default. You can enable it in the airFiber Configuration Interface on the *Network* tab. (See **“Management Network Settings”** on [page 20](#) for more details.)

### Accessing the airFiber Configuration Interface

Connect to the airFiber Configuration Interface.

1. Make sure that your host machine is connected to the LAN that is connected to the *CONFIG* port on the airFiber AF24.
2. Configure the Ethernet adapter on your host system with a static IP address on the 192.168.1.x subnet (for example, 192.168.1.100).

3. Launch your Web browser. Type **http://192.168.1.20** in the address field and press **enter** (PC) or **return** (Mac).



4. Upon initial login, the *Terms of Use* appear on the login screen. Enter **ubnt** in the *Username* and *Password* fields, and select the appropriate choices from the *Country* and *Language* drop-down lists. Check the box next to *I agree to these terms of use*, and click **Login**.

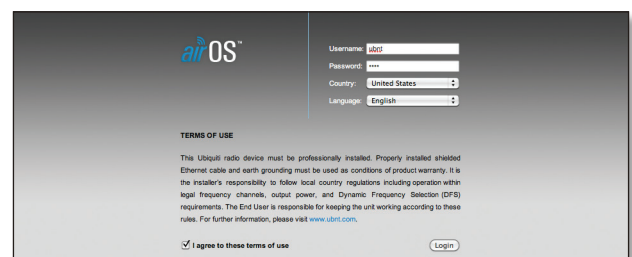

**Note:** U.S. product versions are locked to the U.S. Country Code to ensure compliance with FCC regulations.

5. The airFiber Configuration Interface will appear, allowing you to customize your settings as needed.

## Product Verification

The airFiber Configuration Interface will verify whether a product is genuine or counterfeit.

For a genuine airFiber AF24, the airFiber Configuration Interface will display a Genuine Product logo in the lower left corner of the screen.



For any product that is not an official Ubiquiti product, the airFiber Configuration Interface will display a counterfeit warning. Please contact Ubiquiti at [support@ubnt.com](mailto:support@ubnt.com) regarding this product.



 **Note:** For product models introduced prior to 2012, the airFiber Configuration Interface will NOT display any logo in the lower left corner of the screen.

## Interface Tabs

The airFiber Configuration Interface contains six main tabs, each of which provides a Web-based management page to configure a specific aspect of the airFiber AF24. This User Guide covers each tab with a chapter. For details on a specific tab, refer to the appropriate chapter.

- **Main** The **“Main Tab” on page 16** displays device status, statistics, and network monitoring links.
- **Wireless** The **“Wireless Tab” on page 18** configures basic wireless settings, including the wireless mode, link name, frequency, output power, speed, RX gain, and wireless security.
- **Network** The **“Network Tab” on page 20** configures the management network settings, Internet Protocol (IP) settings, management VLAN, and automatic IP aliasing.
- **Advanced** The **“Advanced Tab” on page 22** provides more precise wireless interface controls, including advanced wireless settings and advanced Ethernet settings.
- **Services** The **“Services Tab” on page 23** configures system management services: Ping Watchdog, Simple Network Management Protocol (SNMP), servers (Web, SSH, telnet), Network Time Protocol (NTP) client, Dynamic Domain Name System (DDNS) client, system log, and device discovery.
- **System** The **“System Tab” on page 27** controls system maintenance routines, administrator account management, location management, device customization, firmware update, and configuration

backup. You can also change the language of the Web management interface.

Each page also contains network administration and monitoring tools:

- **“Align Antenna” on page 30**
- **“Discovery” on page 31**
- **“Ping” on page 31**
- **“Traceroute” on page 31**
- **“RX Speed Test” on page 31**





## Chapter 4: Main Tab

The *Main* tab displays a summary of the link status information, current values of the basic configuration settings, network settings and information, and traffic statistics.

### Status

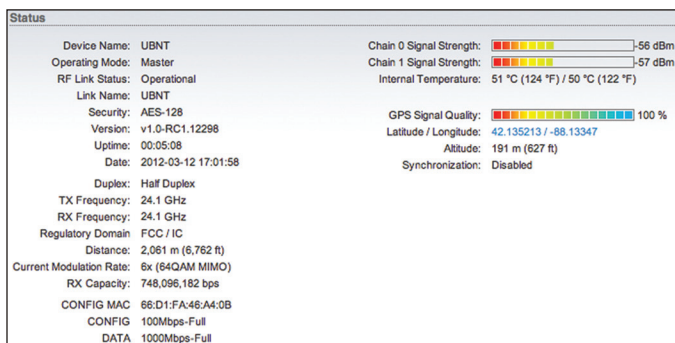

**Device Name** Displays the customizable name or identifier of the device. The Device Name (also known as host name) is displayed in registration screens and discovery tools.

**Operating Mode** Displays the mode of the airFiber AF24: *Slave*, *Master*, or *Reset*.

**RF Link Status** Displays the status of the airFiber AF24: *RF Off*, *Syncing*, *Beaconing*, *Registering*, *Enabling*, *Listening*, or *Operational*.

**Note:** Most of the RF Link Statuses map to specific flash rates of the *RF Link Status* LED (See “**LEDs**” on **page 2** for more details.)

Status	Flash Rate of LED
RF Off	Off
Syncing	Short Flash (1:3 on/off cycle)
Beaconing	Normal Flash (1:1 on/off cycle)
Registering	Long Flash (3:1 on/off cycle)
Operational	On

**Link Name** Displays the name of your link.

**Security** AES-128 is enabled at all times.

**Version** Displays the airFiber Configuration Interface software version.

**Uptime** This is the total time the device has been running since the latest reboot (when the device was powered up) or software upgrade. The time is displayed in days, hours, minutes, and seconds.

**Date** Displays the current system date and time. The date and time are displayed in YEAR-MONTH-DAY HOURS:MINUTES:SECONDS format. The system date and time is retrieved from the Internet using NTP (Network Time Protocol). The NTP Client is enabled by default on the *Services* tab. The airFiber AF24 doesn't have an internal clock, and the date and time may be inaccurate if the NTP Client is disabled or the device isn't connected to the Internet.

**Duplex** Displays *Full Duplex* or *Half Duplex*. Full-duplex mode allows communication in both directions simultaneously. Half-duplex mode allows communication in one direction at a time, alternating between transmission and reception.

**TX Frequency** Displays the current transmit frequency. The airFiber AF24 uses the radio frequency specified to transmit data.

**RX Frequency** Displays the current receive frequency. The airFiber AF24 uses the radio frequency specified to receive data.

**Regulatory Domain** Displays the regulatory domain (*FCC/IC, ETSI, or Other*), as determined by country selection.

**Distance** Displays the distance between the airFiber radios.

**Current Modulation Rate** Displays the modulation rate:

- 6x (64QAM MIMO)
- 4x (16QAM MIMO)
- 2x (QPSK MIMO)
- 1x (QPSK SISO)

If *Automatic Rate Adaptation* is enabled on the *Wireless* tab, then *Current Modulation Rate* displays the current speed in use and depends on the *Maximum Modulation Rate* specified on the *Wireless* tab and current link conditions. (See "**Basic Wireless Settings**" on page 19 for more details.)

**RX Capacity** Displays the raw modulation rate capacity of the link between the airFiber radios.

**CONFIG MAC** Displays the MAC address of the *CONFIG* port.

**CONFIG** Displays the speed and duplex of the *CONFIG* port.

**DATA** Displays the speed and duplex of the *DATA* port.

**Chain 0/1 Signal Strength** Displays the absolute power level (in dBm) of the received signal for each chain.



**Note:** Changing the *RX Gain* on the *Wireless* tab will not affect the *Signal Strength* values displayed on the *Main* tab. (See "**Basic Wireless Settings**" on page 19 for more details about *RX Gain*.)

**Internal Temperature** Displays the temperatures inside the airFiber AF24 for monitoring.

**GPS Signal Quality** Displays Global Positioning System (GPS) signal quality as a percentage value on a scale of 0-100%.

**Latitude/Longitude** Based on GPS tracking, reports the device's current latitude and longitude. Clicking the link opens the reported latitude and longitude in a browser using Google Maps™ (<http://maps.google.com>).

**Altitude** Based on GPS tracking, reports the device's current altitude relative to sea level.

**Synchronization** airFiber uses GPS to synchronize the timing of its transmissions. By default, this option is disabled.

## Monitor

There are two monitoring tools accessible via the links on the *Main* tab. The default is *Throughput*, which is displayed when you first open the *Main* tab.

### Throughput

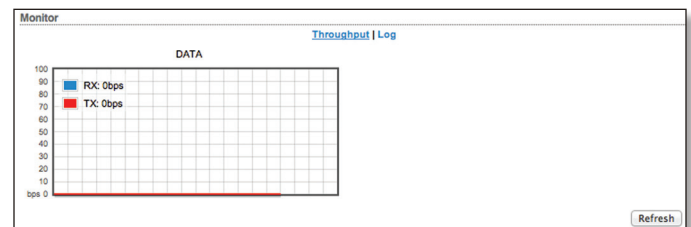

Throughput displays the current data traffic on the *DATA* port in both graphical and numerical form. The chart scale and throughput dimension (Bps, Kbps, Mbps) change dynamically depending on the mean throughput value. The statistics are updated automatically.

**Refresh** If there is a delay in the automatic update, click **Refresh** to manually update the statistics.

### Log

When logging is enabled (see "**System Log**" on page 25 to enable logging), this option lists all registered system events. By default, logging is not enabled.

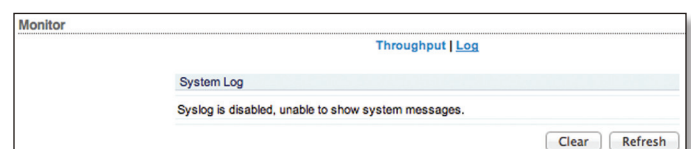

**Clear** To delete all entries in the system log, click **Clear**.

**Refresh** To update the log content, click **Refresh**.



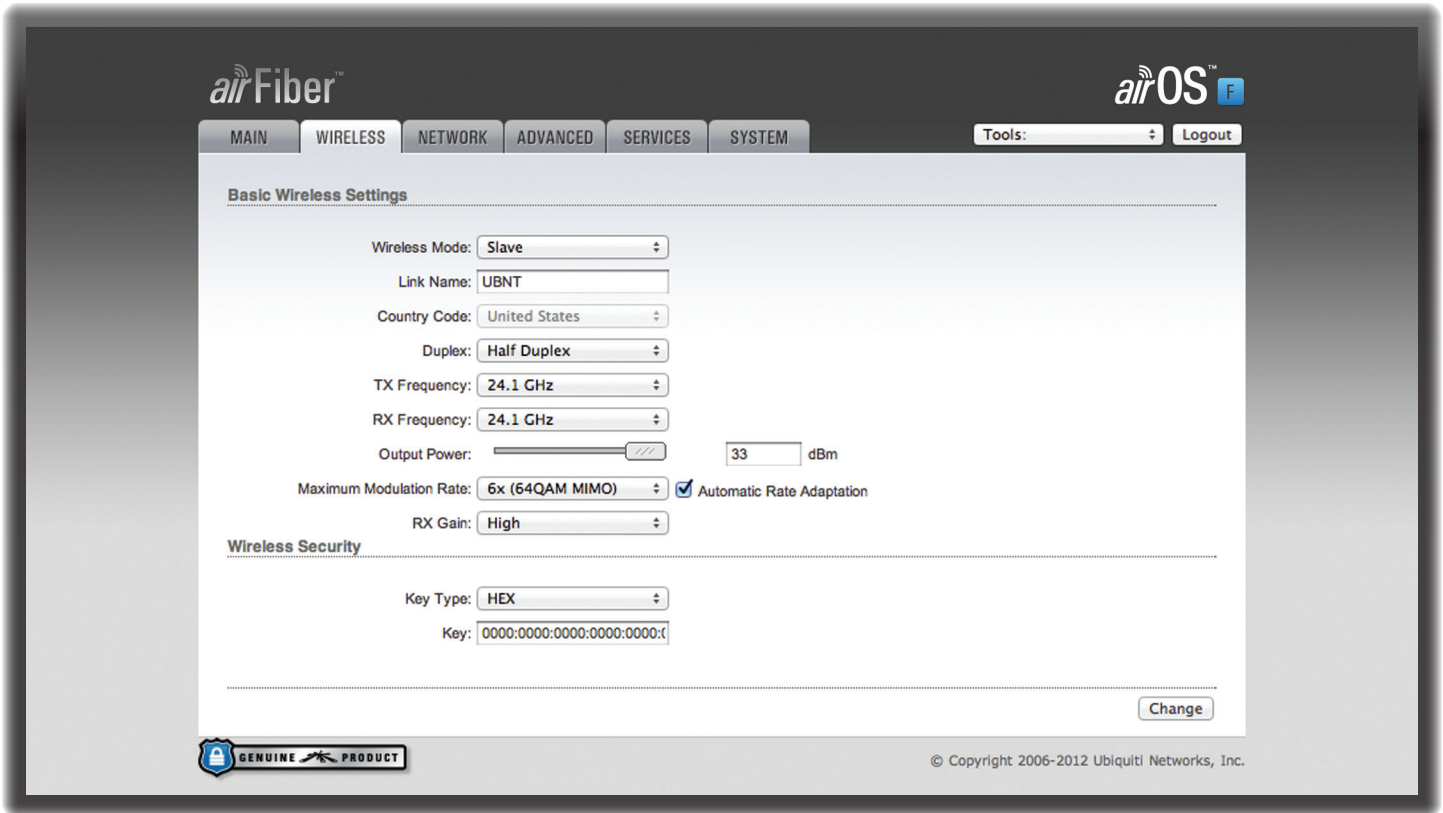

## Chapter 5: Wireless Tab

The *Wireless* tab contains everything needed to set up the wireless part of the link. This includes wireless mode, link name, frequencies, output power, speed, gain, and wireless security.

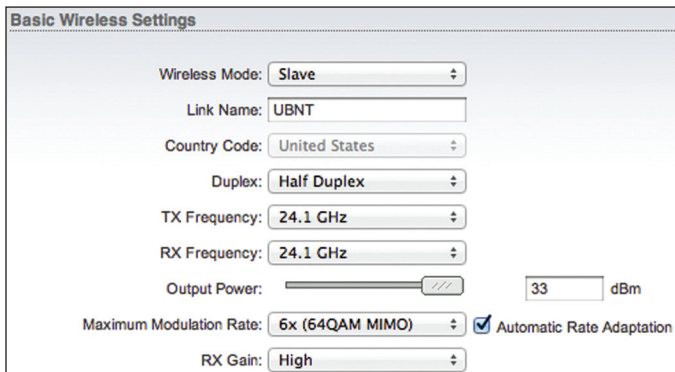

**Change** To save or test your changes, click **Change**.

A new message appears. You have three options:

- **Apply** To immediately save your changes, click **Apply**.
- **Test** To try the changes without saving them, click **Test**. To keep the changes, click **Apply**. If you do not click *Apply* within 180 seconds (the countdown is displayed), the airFiber AF24 times out and resumes its earlier configuration.
- **Discard** To cancel your changes, click **Discard**.

Write down the settings you configure on the *Wireless* tab. You will need to enter the same settings on the airFiber AF24 at the other end of your PtP link. The exceptions are as follows:

- **Wireless Mode** Configure one airFiber AF24 as the *Master* and the other as the *Slave*.
- **TX and RX Frequencies** The *TX Frequency* on the Master should be used as the *RX Frequency* on the Slave, and vice versa.

For *Half Duplex* mode (default), the *TX* and *RX Frequencies* are the same.

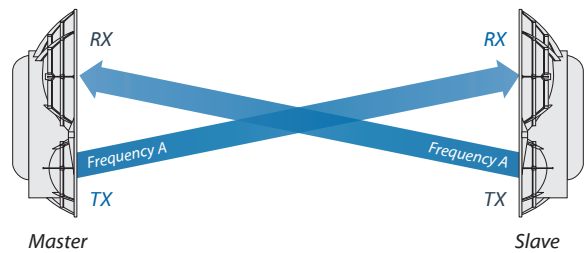

Half-Duplex Diagram

For *Full Duplex* mode, the *TX* and *RX Frequencies* must be different.



Full-Duplex Diagram

## Basic Wireless Settings

In this section, configure the basic wireless settings, such as wireless mode, link name, country code, frequencies, output power, speed, and gain.

**Wireless Mode** By default, the Wireless Mode is *Slave*. You must configure one airFiber AF24 to **Master** because each PtP link must have one *Master*.

**Link Name** Enter a name for your PtP link.

**Country Code** Each country has their own power level and frequency regulations. *To ensure the airFiber AF24 operates under the necessary regulatory compliance rules, you must select the country where your device will be used.* The frequency settings and output power limits will be tuned according to the regulations of the selected country. For further explanation of international compliance requirements, please consult the **RF Compliance Guide** for further explanation of international compliance requirements.

**Duplex** Select **Half Duplex** or **Full Duplex**. Half-duplex operation provides more frequency planning options at the cost of higher latency and throughput. (Half-duplex mode allows communication in one direction at a time, alternating between transmission and reception.) Full-duplex operation provides the highest throughput and lowest latency; however, you have fewer frequency management options. (Full-duplex mode allows communication in both directions simultaneously.)

 **Note:** For *Half Duplex* mode (default), the *TX* and *RX* Frequencies on the same airFiber AF24 are the same. For *Full Duplex* mode, the *TX* and *RX* Frequencies on the same airFiber AF24 must be different.

**TX Frequency** Select a transmit frequency.

 **Note:** The *TX* Frequency on the Master should be used as the *RX* Frequency on the Slave, and vice versa.

**RX Frequency** Select a receive frequency.

**Output Power** Defines the maximum average transmit output power (in dBm) of the airFiber AF24. To specify the output power, use the slider or manually enter the output power value. The transmit power level maximum is limited according to country regulations.

**Maximum Modulation Rate or Modulation Rate** Higher modulations support greater throughput but generally require stronger RF signals and a higher Signal-to-Noise Ratio (SNR). By default, *Automatic Rate Adaptation* is enabled, and *Maximum Modulation Rate* is displayed. This allows the airFiber AF24 to automatically adjust the modulation rate to changing RF signal conditions. Under certain conditions, you may prefer to lock the *Maximum Modulation Rate* to a lower setting to improve link performance.

When *Automatic Rate Adaptation* is disabled, *Modulation Rate* is displayed. Lock the *Modulation Rate* to the setting of your choice.

Select one of the available modulation rates:

- **6x (64QAM MIMO)**
- **4x (16QAM MIMO)**
- **2x (QPSK MIMO)**
- **1x (QPSK SIS0)**

**RX Gain** Select the appropriate gain for your RX antenna: **High** (default) or **Low**. If the link is very short or being tested, select **Low**, so your signal does not get distorted.



**Note:** Minimum link distance is approximately 100 m.

For links between 100m and 800m:

- Target -40 dBm
- Decrease RX Gain to overcome oL condition
- For short ranges/strong signal conditions, adjust the power to be 3-5 dB below “oL” (overload) condition
- Decrease RX gain first
- Never mitigate oL condition by misaiming antennas

Link Distance	RX Gain Setting	Approximate TX Power Setting
d > 1 km	High	> 25 dBm
0.5 km < d < 1 km	Low	19-25 dBm
0.25 km < d < 0.5 km	Low	12-18 dBm
0.1 km < d < 0.25 km	Low	3-11 dBm

## Wireless Security

airFiber uses 128-bit, AES (Advanced Encryption Standard) encryption at all times.

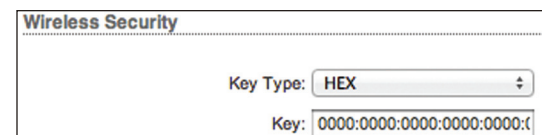

**Key Type** Specifies the character format.

- **HEX** By default, this option uses hexadecimal characters. 0-9, A-F, or a-f are valid characters.
- **ASCII** ASCII uses the standard English alphabet and numeric characters (0-9, A-Z, or a-z).

**Key** Select the format of the MAC address.

- **HEX** Enter 16 bytes (eight, 16-bit HEX values). You can omit zeroes and use colons, similar to the IPv6 format. The default is:  
**0000:0000:0000:0000:0000:0000:0000:0000.**



**Note:** The airFiber Configuration Interface supports IPv6 formats excluding dotted quad and “::” (double-colon) notation.

- **ASCII** Enter a combination of alphanumeric characters. Using 128-bit, SHA1 (Secure Hash Algorithm 1), airFiber AF24 hashes the ASCII key to create a 128-bit key for AES.

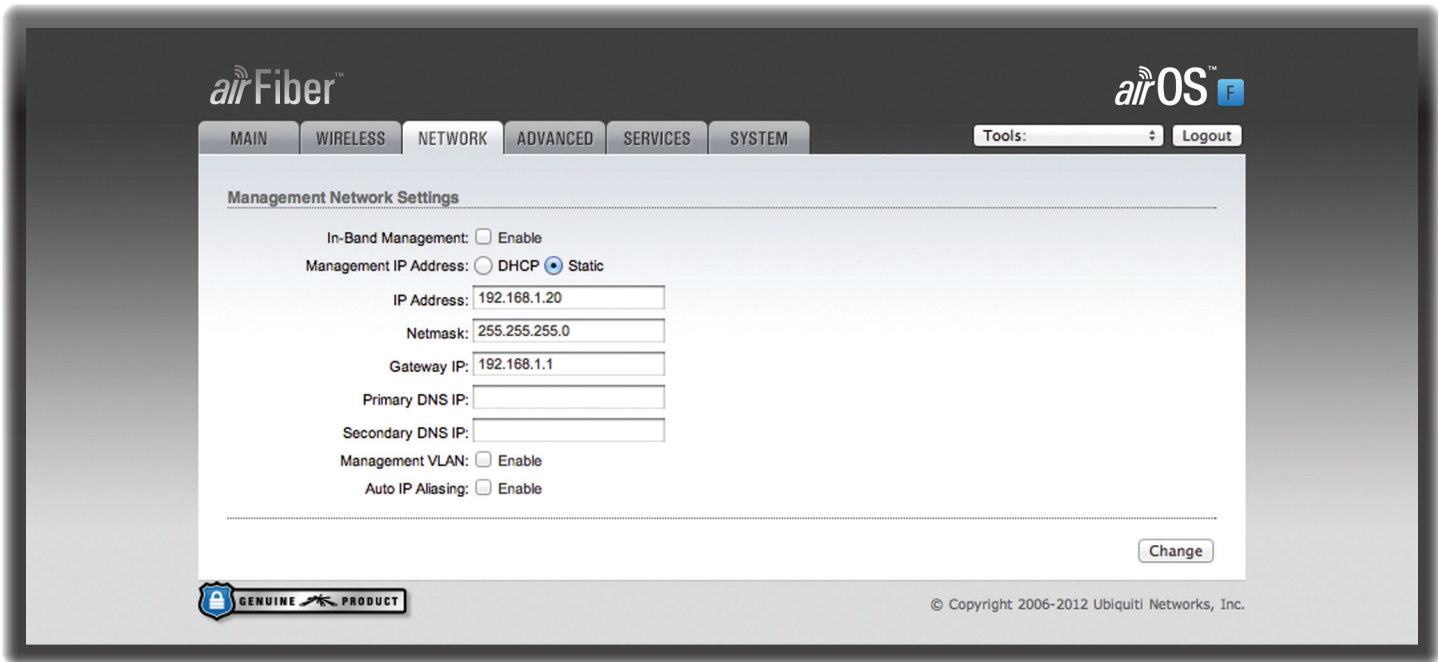

## Chapter 6: Network Tab

The *Network* tab allows you to configure settings for the management network.

There are two ways to access the airFiber Configuration Interface:

- **CONFIG Port** Enabled by default. Use a direct connection to the *CONFIG* port for out-of-band management.
- **In-Band Management** Disabled by default. You can enable it on the *Network* tab to allow management through the local *DATA* port or the *DATA* port at the other end of the link.

The *CONFIG* port and in-band management share the default IP address of *192.168.1.20*.

**Change** To save or test your changes, click **Change**.

A new message appears. You have three options:

- **Apply** To immediately save your changes, click **Apply**.
- **Test** To try the changes without saving them, click **Test**. To keep the changes, click **Apply**. If you do not click *Apply* within 180 seconds (the countdown is displayed), the airFiber AF24 times out and resumes its earlier configuration.
- **Discard** To cancel your changes, click **Discard**.

## Management Network Settings

**In-Band Management** Disabled by default. To enable in-band management through the local *DATA* port or the *DATA* port at the other end of the link, select the checkbox.



**Note:** If *In-Band Management* is enabled, ensure that each airFiber radio of a link has a unique *IP Address*. If the airFiber radios use the same *IP Address*, then you may lose access via the *DATA* and *CONFIG* ports.

**Management IP Address** The airFiber AF24 can use a static IP address or obtain an IP address from its DHCP server.

- **DHCP** The local DHCP server assigns a dynamic IP address, gateway IP address, and DNS address to the airFiber AF24.



**Note:** We do not recommend the *DHCP* option because if you do not know the IP address, then the only way to manage the airFiber AF24 is to reset the airFiber AF24 to its factory default settings. (Press and hold the **Reset** button for more than five seconds.) Its default *Management IP Address* is reset to *192.168.1.20*.

**Management Network Settings**

In-Band Management:  Enable

Management IP Address:  DHCP  Static

DHCP Fallback IP:

DHCP Fallback Netmask:

Management VLAN:  Enable

VLAN ID:

Auto IP Aliasing:  Enable

- **DHCP Fallback IP** Specify the IP address the airFiber AF24 should use if a DHCP server is not found.
- **DHCP Fallback Netmask** Specify the netmask the airFiber AF24 should use if a DHCP server is not found.
- **Static** Assign static IP settings to the airFiber AF24.



**Note:** IP settings should be consistent with the address space of the airFiber AF24's network segment.

**Management Network Settings**

In-Band Management:  Enable

Management IP Address:  DHCP  Static

IP Address:

Netmask:

Gateway IP:

Primary DNS IP:

Secondary DNS IP:

Management VLAN:  Enable

VLAN ID:

Auto IP Aliasing:  Enable

- **IP Address** Specify the IP address of the airFiber AF24. This IP will be used for device management purposes.
- **Netmask** When the netmask is expanded into its binary form, it provides a mapping to define which portions of the IP address range are used for the network devices and which portions are used for host devices. The netmask defines the address space of the airFiber AF24's network segment. The 255.255.255.0 (or "/24") netmask is commonly used on many Class C IP networks.
- **Gateway IP** Typically, this is the IP address of the host router, which provides the point of connection to the Internet. This can be a DSL modem, cable modem, or WISP gateway router. The airFiber AF24 directs data packets to the gateway if the destination host is not within the local network.
- **Primary DNS IP** Specify the IP address of the primary DNS (Domain Name System) server.
- **Secondary DNS IP** Specify the IP address of the secondary DNS server. This entry is optional and used only if the primary DNS server is not responding.

**Management VLAN** If enabled, automatically creates a management Virtual Local Area Network (VLAN).

- **VLAN ID** Enter a unique VLAN ID from 2 to 4094.

**Auto IP Aliasing** If enabled, automatically generates an IP address for the corresponding WLAN/LAN interface. The generated IP address is a unique Class B IP address from the 169.254.X.Y range (netmask 255.255.0.0), which is intended for use within the same network segment only. The Auto IP always starts with 169.254.X.Y, with X and Y as the last two octets from the MAC address of the airFiber AF24. For example, if the MAC address is 00:15:6D:A3:04:FB, then the generated unique Auto IP will be 169.254.4.251. (The hexadecimal value, *FB*, converts to the decimal value, *251*.)

The Auto IP Aliasing setting can be useful because you can still access and manage devices even if you lose, misconfigure, or forget their IP addresses. Because an Auto IP address is based on the last two octets of the MAC address, you can determine the IP address of a device if you know its MAC address.



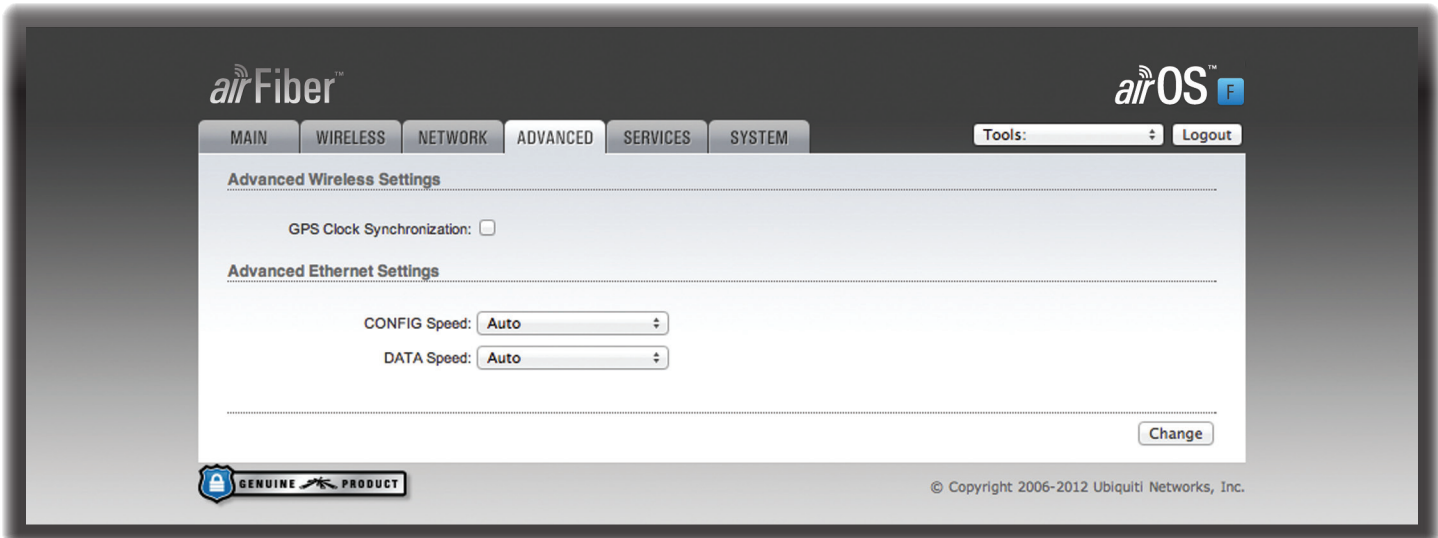

## Chapter 7: Advanced Tab

The *Advanced* tab handles advanced wireless and Ethernet settings. These settings should not be changed unless you know the effects the changes will have on the airFiber AF24.

**Change** To save or test your changes, click **Change**.

A new message appears. You have three options:

- **Apply** To immediately save your changes, click **Apply**.
- **Test** To try the changes without saving them, click **Test**. To keep the changes, click **Apply**. If you do not click *Apply* within 180 seconds (the countdown is displayed), the airFiber AF24 times out and resumes its earlier configuration.
- **Discard** To cancel your changes, click **Discard**.

### Advanced Wireless Settings

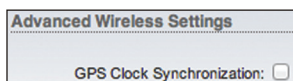

**GPS Clock Synchronization** The airFiber uses GPS to synchronize the timing of its transmissions. By default, this option is disabled.

### Advanced Ethernet Settings

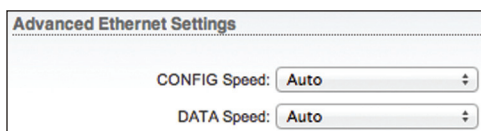

**CONFIG Speed** This is the speed of the *CONFIG* port. By default, the option is **Auto**. The airFiber AF24 automatically negotiates transmission parameters, such as speed and duplex, with its counterpart. In this process, the networked devices first share their capabilities and then choose the fastest transmission mode they both support.

To manually specify the maximum transmission link speed and duplex mode, select one of the following options: **100 Mbps-Full**, **100 Mbps-Half**, **10 Mbps-Full**, or **10 Mbps-Half**. If you are running extra long Ethernet cables, a link speed of *10 Mbps* could help to achieve better stability.

Full-duplex mode allows communication in both directions simultaneously. Half-duplex mode allows communication in one direction at a time, alternating between transmission and reception.

**DATA Speed** This is the speed of the *DATA* port. By default, the option is **Auto**. The airFiber AF24 automatically negotiates transmission parameters, such as speed and duplex, with its counterpart. In this process, the networked devices first share their capabilities and then choose the fastest transmission mode they both support.

To manually specify the maximum transmission link speed and duplex mode, select one of the following options: **1000 Mbps-Full**, **100 Mbps-Full**, **100 Mbps-Half**, **10 Mbps-Full**, or **10 Mbps-Half**. To achieve full performance with extra-long Ethernet cables, ensure that you use CAT6 qualified cables and interconnects.

Full-duplex mode allows communication in both directions simultaneously. Half-duplex mode allows communication in one direction at a time, alternating between transmission and reception.

The screenshot shows the 'Services' tab in the airFiber web interface. The navigation menu at the top includes MAIN, WIRELESS, NETWORK, ADVANCED, SERVICES (selected), and SYSTEM. The 'Tools' dropdown is set to 'Tools' and there is a 'Logout' button. The configuration page is organized into several sections:

- Ping Watchdog:** Includes checkboxes for 'Enable', input fields for 'IP Address To Ping', 'Ping Interval' (300 seconds), 'Startup Delay' (300 seconds), 'Failure Count To Reboot' (3), and a 'Save Support Info' checkbox.
- SNMP Agent:** Includes checkboxes for 'Enable', input fields for 'SNMP Community' (public), 'Contact', and 'Location'.
- Web Server:** Includes checkboxes for 'Secure Connection (HTTPS)' and 'Enable', input fields for 'Secure Server Port' (443), 'Server Port' (80), and 'Session Timeout' (5 minutes).
- SSH Server:** Includes checkboxes for 'SSH Server' and 'Password Authentication' (both checked), an input field for 'Server Port' (22), and an 'Authorized Keys' button.
- Telnet Server:** Includes checkboxes for 'Telnet Server' and 'Enable', and an input field for 'Server Port' (23).
- NTP Client:** Includes checkboxes for 'NTP Client' and 'Enable', and an input field for 'NTP Server' (0.ubnt.pool.ntp.org).
- Dynamic DNS:** Includes checkboxes for 'Dynamic DNS' and 'Enable', input fields for 'Host Name', 'Username', and 'Password', and a 'Show' checkbox.
- System Log:** Includes checkboxes for 'System Log' and 'Remote Log' (both unchecked), an input field for 'Remote Log IP Address', and an input field for 'Remote Log Port' (514).
- Device Discovery:** Includes checkboxes for 'Discovery' and 'CDP' (both checked).

A 'Change' button is located at the bottom right of the configuration area. At the bottom left, there is a 'GENUINE PRODUCT' logo, and at the bottom right, the copyright notice reads '© Copyright 2006-2012 Ubiquiti Networks, Inc.'

## Chapter 8: Services Tab

The *Services* tab configures system management services: *Ping Watchdog*, *SNMP Agent*, *Web Server*, *SSH Server*, *Telnet Server*, *NTP Client*, *Dynamic DNS*, *System Log*, and *Device Discovery*.

**Change** To save or test your changes, click **Change**.

A new message appears. You have three options:

- **Apply** To immediately save your changes, click **Apply**.
- **Test** To try the changes without saving them, click **Test**. To keep the changes, click **Apply**. If you do not click *Apply* within 180 seconds (the countdown is displayed), the airFiber AF24 times out and resumes its earlier configuration.
- **Discard** To cancel your changes, click **Discard**.

## Ping Watchdog

*Ping Watchdog* sets the airFiber AF24 to continuously ping a user-defined IP address (it can be the Internet gateway, for example). If it is unable to ping under the user-defined constraints, then the airFiber AF24 will automatically reboot. This option creates a kind of “fail-proof” mechanism.

*Ping Watchdog* is dedicated to continuous monitoring of the specific connection to the remote host using the *Ping* tool. The *Ping* tool works by sending ICMP echo request packets to the target host and listening for ICMP echo response replies. If the defined number of replies is not received, the tool reboots the airFiber AF24.

**Ping Watchdog** Enables use of *Ping Watchdog*.

- **IP Address To Ping** Specify the IP address of the target host to be monitored by *Ping Watchdog*.
- **Ping Interval** Specify the time interval (in seconds) between the ICMP echo requests that are sent by *Ping Watchdog*. The default value is 300 seconds.
- **Startup Delay** Specify the initial time delay (in seconds) until the first ICMP echo requests are sent by *Ping Watchdog*. The default value is 300 seconds.  
The Startup Delay value should be at least 60 seconds as the network interface and wireless connection initialization takes a considerable amount of time if the airFiber AF24 is rebooted.
- **Failure Count to Reboot** Specify the number of ICMP echo response replies. If the specified number of ICMP echo response packets is not received continuously, *Ping Watchdog* will reboot the airFiber AF24. The default value is 3.
- **Save Support Info** This generates a support information file.

## SNMP Agent

Simple Network Monitor Protocol (SNMP) is an application layer protocol that facilitates the exchange of management information between network devices. Network administrators use SNMP to monitor network-attached devices for issues that warrant attention.

The airFiber AF24 contains an *SNMP Agent*, which does the following:

- Provides an interface for device monitoring using SNMP
- Communicates with SNMP management applications for network provisioning
- Allows network administrators to monitor network performance and troubleshoot network problems

For the purpose of equipment identification, configure the *SNMP Agent* with contact and location information:

**SNMP Agent** Enables the *SNMP Agent*.

- **SNMP Community** Specify the SNMP community string. It is required to authenticate access to Management Information Base (MIB) objects and functions as an embedded password. The airFiber AF24 also supports a read-only community string; authorized management stations have read access to all the objects in the MIB except the community strings, but do not have write access. The airFiber AF24 supports SNMP v1. The default SNMP Community is *public*.
- **Contact** Specify the contact who should be notified in case of emergency.
- **Location** Specify the physical location of the airFiber AF24.

## Web Server

The following *Web Server* parameters can be set:

**Secure Connection (HTTPS)** If enabled, the *Web Server* uses secure HTTPS mode.

- **Secure Server Port** If secure HTTPS mode is used, specify the TCP/IP port of the *Web Server*.

**Server Port** If HTTP mode is used, specify the TCP/IP port of the *Web Server*.

**Session Timeout** Specifies the maximum timeout before the session expires. Once a session expires, you must log in again using the username and password.

## SSH Server

The following *SSH Server* parameters can be set:

**SSH Server** This option enables SSH access to the airFiber AF24.

- **Server Port** Specify the TCP/IP port of the *SSH Server*.
- **Password Authentication** If enabled, you must authenticate using administrator credentials to grant SSH access to the airFiber AF24; otherwise, an authorized key is required.
- **Authorized Keys** Click **Edit** to import a public key file for SSH access to the airFiber AF24 instead of using an admin password.

- **Choose File** Click **Choose File** to locate the new key file. Select the file and click **Open**.
- **Import** Imports the file for SSH access.
- **Enabled** Enables the specific key. All the added keys are saved in the system configuration file; however, only the enabled keys are active on the airFiber AF24.
- **Type** Displays the type of key.
- **Key** Displays the key.
- **Comment** You can enter a brief description of the key.
- **Action** You have the following options:
  - **Add** Adds a public key file.
  - **Edit** Make changes to a public key file. Click **Save** to save your changes.
  - **Del** Deletes a public key file.
- **Save** Saves your changes.
- **Close** Discards your changes.

## Telnet Server

The following *Telnet Server* parameters can be set:

- Telnet Server** This option activates Telnet access to the airFiber AF24.
- **Server Port** Specify the TCP/IP port of the *Telnet Server*.

## NTP Client

Network Time Protocol (NTP) is a protocol for synchronizing the clocks of computer systems over packet-switched, variable-latency data networks. You can use it to set the system time on the airFiber AF24. If the *Log* option is enabled, then the system time is reported next to every log entry that registers a system event.

**NTP Client** Enables the airFiber AF24 to obtain the system time from a time server on the Internet.

- **NTP Server** Specify the IP address or domain name of the NTP server.

## Dynamic DNS

Domain Name System (DNS) translates domain names to IP addresses; Each DNS server on the Internet holds these mappings in its respective DNS database. Dynamic Domain Name System (DDNS) is a network service that notifies the DNS server in real time of any changes in the airFiber AF24's IP settings. Even if the airFiber AF24's IP address changes, you can still access the airFiber AF24 through its domain name.

**Dynamic DNS** If enabled, the airFiber AF24 allows communications with the DDNS server.

- **Host Name** Enter the host name of the DDNS server.
- **Username** Enter the user name of the DDNS account.
- **Password** Enter the password of the DDNS account.
- **Show** Check the box to display the password characters.

## System Log

**System Log** This option enables the registration routine of system log (syslog) messages. By default it is disabled.

- **Remote Log** Enables the syslog remote sending function. System log messages are sent to a remote server, which is specified in the *Remote Log IP Address* and *Remote Log Port* fields.
  - **Remote Log IP Address** The host IP address that receives syslog messages. Properly configure the remote host to receive syslog protocol messages.
  - **Remote Log Port** The TCP/IP port that receives syslog messages. *514* is the default port for the commonly used system message logging utilities.

Every logged message contains at least a system time and host name. Usually a specific service name that generates the system event is also specified within the message. Messages from different services have different contexts and different levels of detail. Usually error, warning, or informational system service messages are reported; however, more detailed debug level messages can also be reported. The more detailed the system messages reported, the greater the volume of log messages generated.



## Device Discovery



**Discovery** Enables device discovery, so the airFiber AF24 can be discovered by other Ubiquiti devices through the *Discovery* tool.

**CDP** Enables Cisco Discovery Protocol (CDP) communications, so the airFiber AF24 can send out CDP packets to share its information.

The screenshot displays the 'System' tab in the airFiber web interface. At the top, there are navigation tabs: MAIN, WIRELESS, NETWORK, ADVANCED, SERVICES, and SYSTEM. The 'SYSTEM' tab is selected. The page is titled 'airFiber™' and 'airOS™'. A 'Tools' dropdown and a 'Logout' button are in the top right. The main content area is divided into several sections:

- Firmware Update:** Shows 'Firmware Version: AF.v1.0-RC1.12298.120316.1659' and 'Build Number: 12298'. There is an 'Upload Firmware:' section with a 'Choose File' button and 'No file chosen' text. Below this, 'Check for Updates:' is set to 'Enable' with a 'Check Now' button.
- Device:** 'Device Name:' is 'UBNT' and 'Interface Language:' is 'English'.
- Date Settings:** 'Time Zone:' is '(GMT) Western Europe'. 'Startup Date:' has an 'Enable' checkbox and a date picker.
- System Accounts:** 'Administrator Username:' is 'ubnt'. 'Read-Only Account:' has an 'Enable' checkbox.
- Miscellaneous:** 'Reset Button:' is 'Enable'.
- Location:** 'Latitude:' is '42.135213' and 'Longitude:' is '-88.13347'. A 'Change' button is at the bottom right of this section.
- Device Maintenance:** 'Reboot Device:' has a 'Reboot...' button. 'Support Info:' has a 'Download...' button.
- Configuration Management:** 'Back Up Configuration:' has a 'Download...' button. 'Upload Configuration:' has a 'Choose File' button and 'No file chosen' text. 'Reset to Factory Defaults:' has a 'Reset...' button.

At the bottom left, there is a 'GENUINE PRODUCT' logo. At the bottom right, the copyright notice reads '© Copyright: 2006-2012 Ubiquiti Networks, Inc.'

## Chapter 9: System Tab

The *System* tab contains administrative options. This page enables the administrator to reboot the airFiber AF24, reset it to factory defaults, upload new firmware, back up or update the configuration, and configure the administrator account.

**Change** To save or test your changes, click **Change**.

A new message appears. You have three options:

- **Apply** To immediately save your changes, click **Apply**.
- **Test** To try the changes without saving them, click **Test**. To keep the changes, click **Apply**. If you do not click *Apply* within 180 seconds (the countdown is displayed), the airFiber AF24 times out and resumes its earlier configuration.
- **Discard** To cancel your changes, click **Discard**.

## Firmware Update

The controls in this section manage firmware maintenance.

This screenshot shows a close-up of the 'Firmware Update' section. It displays the 'Firmware Version: AF.v1.0-RC1.12298.120316.1659' and 'Build Number: 12298'. The 'Upload Firmware:' section includes a 'Choose File' button and 'No file chosen' text. The 'Check for Updates:' section is set to 'Enable' with a 'Check Now' button.

**Firmware Version** Displays the current firmware version.

**Build Number** Displays the build number of the firmware version.

**Check for Updates** By default, the firmware automatically checks for updates. To manually check for an update, click **Check Now**.

**Upload Firmware** Click this button to update the airFiber AF24 with new firmware.

The airFiber AF24 firmware update is compatible with all configuration settings. The system configuration is preserved while the airFiber AF24 is updated with a new firmware version. However, we recommend that you back up your current system configuration before updating the firmware.

This is a three-step procedure:

1. Click **Choose File** to locate the new firmware file. Select the file and click **Open**.
2. Click **Upload** to upload the new firmware to the airFiber AF24.
3. The Uploaded Firmware Version is displayed. Click **Update** to confirm.

If the firmware update is in process, you can close the firmware update window, but this does not cancel the firmware update. Please be patient, as the firmware update routine can take three to seven minutes. You cannot access the airFiber AF24 until the firmware update routine is completed.



**WARNING:** Do not power off, do not reboot, and do not disconnect the airFiber AF24 from the power supply during the firmware update process as these actions will damage the airFiber AF24!

## Device

The Device Name (host name) is the system-wide device identifier. The SNMP agent reports it to authorized management stations. The Device Name will be used in popular router operating systems, registration screens, and discovery tools.

**Device Name** Specifies the host name.

**Interface Language** Allows you to select the language displayed in the Web management interface. *English* is the default language.

You may upload additional language profiles. Refer to our wiki page at the following URL:

[www.ubnt.com/wiki/How\\_to\\_import\\_Language\\_Profile](http://www.ubnt.com/wiki/How_to_import_Language_Profile)

## Date Settings

**Time Zone** Specifies the time zone in relation to Greenwich Mean Time (GMT).

**Startup Date** When enabled, you are able to change the airFiber AF24's startup date.

- **Startup Date** Specifies the airFiber AF24's startup date. Click the **Calendar** icon or manually enter the date in the following format: 2-digit month/2-digit day/4-digit year. For example, for April 5, 2012, enter **04/05/2012** in the field.

## System Accounts

You can change the administrator password to protect your device from unauthorized changes. We recommend that you change the default administrator password when initially configuring the device.

**Administrator Username** Specifies the name of the administrator.

**Key button** Click this button to change the administrator password.

- **Current Password** Enter the current password for the administrator account. It is required to change the *Password* or *Administrator Username*.
- **New Password** Enter the new password for the administrator account.
- **Verify New Password** Re-enter the new password for the administrator account.



**Note:** The password length is 8 characters maximum; passwords exceeding 8 characters will be truncated.

**Read-Only Account** Check the box to enable the read-only account, which can only view the *Main* tab. Configure the username and password to protect your device from unauthorized changes.

- **Read-Only Account Name** Specifies the name of the system user.
- **Key button** Click this button to change the read-only password.
  - **New Password** Enter the new password for the read-only account.
  - **Show** Check the box to display the read-only password characters.

## Miscellaneous

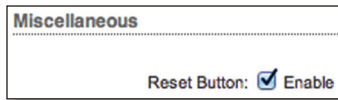

**Reset Button** To allow use of the airFiber AF24's physical reset button, check the box. To prevent an accidental reset to default settings, uncheck the box.



**Note:** You can reset the airFiber AF24 to default settings via the airFiber Configuration Interface. Go to the *System* tab > *Reset to Defaults*.

## Location

After the on-board GPS determines the location of the airFiber AF24, its latitude and longitude are displayed. If the GPS does not have a fix on its location, then "Searching for Satellites" will be displayed.

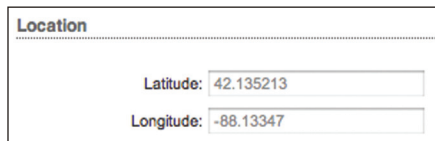

**Latitude** The latitude of the airFiber AF24's location is displayed.

**Longitude** The longitude of the airFiber AF24's location is displayed.

## Device Maintenance

The controls in this section manage the airFiber AF24 maintenance routines: reboot and support information reports.

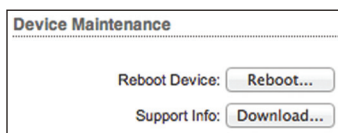

**Reboot Device** Initiates a full reboot cycle of the airFiber AF24. Reboot is the same as the hardware reboot, which is similar to the power-off and power-on cycle. The system configuration stays the same after the reboot cycle completes. Any changes that have not been applied are lost.

**Support Info** This generates a support information file that the Ubiquiti support engineers can use when providing customer support. This file only needs to be generated at their request.

## Configuration Management

The controls in this section manage the airFiber AF24 configuration routines and the option to reset the airFiber AF24 to factory default settings.

The airFiber AF24 configuration is stored in a plain text file (.cfg file). You can back up, restore, or update the system configuration file:

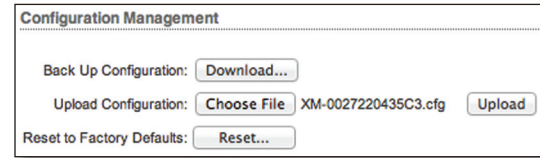

**Back Up Configuration** Click **Download** to download the current system configuration file.

**Upload Configuration** Click **Choose File** to locate the new configuration file. Select the file and click **Open**. We recommend that you back up your current system configuration before uploading the new configuration.

**Upload** Click this button to upload the new configuration file to the airFiber AF24. Click **Apply** to confirm.

After the airFiber AF24 reboots, the settings of the new configuration are displayed in the *Wireless*, *Network*, *Advanced*, *Services*, and *System* tabs of the airFiber Configuration Interface.

**Reset to Factory Defaults** Resets the airFiber AF24 to the factory default settings. This option will reboot the airFiber AF24, and all factory default settings will be restored. We recommend that you back up your current system configuration before resetting the airFiber AF24 to its defaults.

The screenshot displays the airFiber Configuration Interface with the SYSTEM tab selected. The interface is organized into several sections:

- Firmware Update:** Shows Firmware Version: AF.v1.0-RC1.12298.120316.1659, Build Number: 12298, and an Upload Firmware section with a 'Choose File' button and 'No file chosen' status. A 'Check for Updates' section has 'Enable' checked and a 'Check Now' button.
- Device:** Device Name: UBNT, Interface Language: English.
- Date Settings:** Time Zone: (GMT) Western Europe, Startup Date: Enable (unchecked), and a date selection field.
- System Accounts:** Administrator Username: ubnt, Read-Only Account: Enable (unchecked).
- Miscellaneous:** Reset Button: Enable (checked).
- Location:** Latitude: 42.135213, Longitude: -88.13347, and a 'Change' button.
- Device Maintenance:** Reboot Device: Reboot..., Support Info: Download...
- Configuration Management:** Back Up Configuration: Download..., Upload Configuration: Choose File (No file chosen), Reset to Factory Defaults: Reset...

At the bottom left is a 'GENUINE PRODUCT' logo, and at the bottom right is the copyright notice: © Copyright 2006-2012 Ubiquiti Networks, Inc.

## Chapter 10: Tools

Each tab of the airFiber Configuration Interface contains network administration and monitoring tools. Click the **Tools** drop-down list at the top right corner of the page.

### Align Antenna

Use the *Align Antenna* tool to point and optimize the antenna in the direction of maximum link signal. (See [“Aiming Using the airFiber Configuration Interface” on page 10](#) for more details.) The *Antenna Alignment* window reloads every second.



**Chain 0/1 Signal Strength** Displays the absolute power level (in dBm) of the received signal for each chain.



**Note:** Changing the *RX Gain* on the *Wireless* tab will not affect the *Signal Strength* values displayed on the *Main* tab. (See [“Basic Wireless Settings” on page 19](#) for more details about *RX Gain*.)

**Max Signal** Displays the maximum signal strength (in dBm). To adjust the range of the *Max Signal* meter, use the slider or manually enter the new value. If you reduce the range, the color change will be more sensitive to signal fluctuations, indicating the offset of the maximum indicator value and the scale itself.



## Discovery

The *Device Discovery* tool searches for all Ubiquiti devices on your network. The *Search* field automatically filters devices containing specified names or numbers as you enter them.

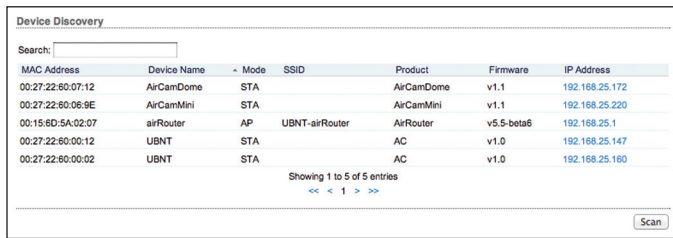

MAC Address	Device Name	Mode	SSID	Product	Firmware	IP Address
00:27:22:80:07:12	AirCamDome	STA		AirCamDome	v1.1	192.168.25.172
00:27:22:80:06:9E	AirCamMini	STA		AirCamMini	v1.1	192.168.25.220
00:15:8D:5A:02:07	airRouter	AP	UBNT-airRouter	AirRouter	v5.5-beta6	192.168.25.1
00:27:22:80:00:12	UBNT	STA		AC	v1.0	192.168.25.147
00:27:22:80:00:02	UBNT	STA		AC	v1.0	192.168.25.160

Showing 1 to 5 of 5 entries  
 << < 1 > >>

It reports the *MAC Address* (except for airFiber devices), *Device Name*, *Mode*, *SSID*, *Product* type, *Firmware* version, and *IP Address* for each Ubiquiti device. To access a device configuration through its Web management interface, click the device's IP address.

To refresh the window, click **Scan**.

## Ping

You can ping other devices on the network directly from the airFiber AF24. The *Ping* tool uses ICMP packets to check the preliminary link quality and packet latency estimation between two network devices.

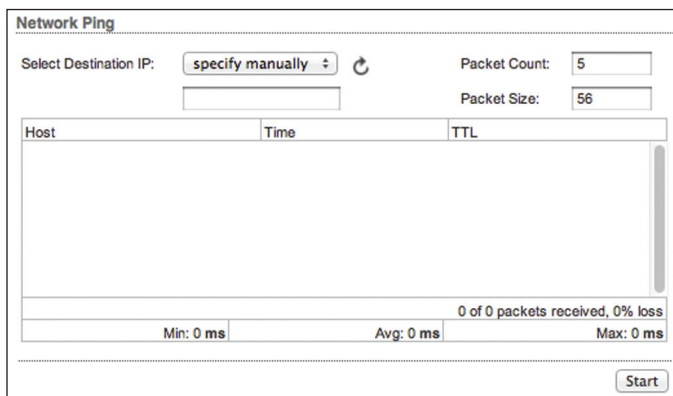

Network Ping

Select Destination IP:   Packet Count:   
 Packet Size:

Host	Time	TTL
0 of 0 packets received, 0% loss		
Min: 0 ms Avg: 0 ms Max: 0 ms		

## Network Ping

**Select Destination IP** You have two options:

- Select a remote system IP from the drop-down list, which is generated automatically.
- Select **specify manually** and enter the IP address in the field displayed below.

**Packet Count** Enter the number of packets to send for the ping test.

**Packet Size** Specify the size of the packet.

**Start** Click this button to start the test.

Packet loss statistics and latency time evaluation are displayed after the test is completed.

## Traceroute

The *Traceroute* tool traces the hops from the airFiber AF24 to a specified outgoing IP address. Use this tool to find the route taken by ICMP packets across the network to the destination host.



Network Traceroute

Destination Host:   Resolve IP Addresses

#	Host	IP	Responses
Start			

**Destination Host** Enter the IP address of the destination host.

**Resolve IP Addresses** Select this option to resolve the IP addresses symbolically rather than numerically.

**Start** Click this button to start the test.

Responses are displayed after the test is completed.

## RX Speed Test

This utility allows you to test the connection speed between two airFiber radios. You can use the *RX Speed Test* to estimate a preliminary throughput between these two devices.

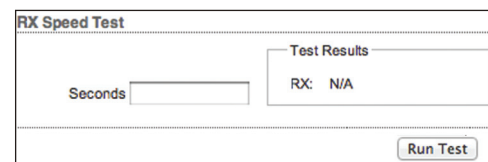

RX Speed Test

Seconds:  Test Results: RX: N/A

**Seconds** Enter the duration of the test.

**Run Test** Click this button to start the test.

**Test Results** Displays three result categories:

- **RX** Displays the estimated incoming throughput.

## Appendix A: Specifications

airFiber AF24	
Operating Frequency	24.05 – 24.25 GHz
Dimensions	649 x 426 x 303 mm
Weight	10.5 kg (Mount Included)
Max. Power Consumption	< 50W
Power Supply	50V, 1.2A PoE GigE Adapter (Included)
Power Method	Passive Power over Ethernet (42-58VDC)
Certifications	CE, FCC, IC
Mounting	Pole Mount Kit (Included)
Operating Temperature	-40 to 55°C (-40 to 131° F)
LEDs	(8) Status LEDs: Data Port Speed Data Port Link/Activity Configuration Port Speed Configuration Port Link/Activity GPS Synchronization Modulation Mode Master/Slave RF Status (1) Two-Digit LED Display Calibrated in dBm
Button	Reset
Interface	
Data Port	(1) 10/100/1000 Ethernet Port
Configuration Port	(1) 10/100 Ethernet Port
Auxiliary Port	(1) RJ-12, Alignment Tone Port
System	
Maximum Throughput	1.4 Gbps
Maximum Range	13 km
Packets per Second	> 1 Million
Encryption	128-Bit AES
Forward Error Correction	164/205
Cyclic Prefix	1/16 Fixed
Uplink/Downlink Ratio	50% Fixed

Radio Frequency	
GPS	GPS Clock Synchronization
Transceiver	
EIRP	~33 dBm
Frequency Accuracy	+/-2.5 ppm without GPS Synchronization +/- 0.2 ppm with GPS Synchronization
Channel Bandwidth	100 MHz
Operating Channels	24.1 GHz, 24.2 GHz
Modulation	64QAM MIMO 16QAM MIMO QPSK MIMO QPSK SISO
Integrated Split Antenna	
Gain	33 dBi
Beamwidth	< 3.5°
Front-to-Back Ratio	30 dB
Polarity	Dual-Slant Polarization
Cross-Polarity Isolation	> 28 dB



## Appendix B: Safety Notices

---

1. Read, follow, and keep these instructions.
2. Heed all warnings.
3. Only use attachments/accessories specified by the manufacturer.

 **WARNING:** Do not use this product in location that can be submerged by water.

 **WARNING:** Avoid using this product during an electrical storm. There may be a remote risk of electric shock from lightning.

### Electrical Safety Information

1. Compliance is required with respect to voltage, frequency, and current requirements indicated on the manufacturer's label. Connection to a different power source than those specified may result in improper operation, damage to the equipment or pose a fire hazard if the limitations are not followed.
2. There are no operator serviceable parts inside this equipment. Service should be provided only by a qualified service technician.
3. This equipment is provided with a detachable power cord which has an integral safety ground wire intended for connection to a grounded safety outlet.
  - a. Do not substitute the power cord with one that is not the provided approved type. Never use an adapter plug to connect to a 2-wire outlet as this will defeat the continuity of the grounding wire.
  - b. The equipment requires the use of the ground wire as a part of the safety certification, modification or misuse can provide a shock hazard that can result in serious injury or death.
  - c. Contact a qualified electrician or the manufacturer if there are questions about the installation prior to connecting the equipment.
  - d. Protective earthing is provided by Listed AC adapter. Building installation shall provide appropriate short-circuit backup protection.
  - e. Protective bonding must be installed in accordance with local national wiring rules and regulations.

## Appendix C: Warranty

### General Warranty

UBIQUITI NETWORKS, Inc (“UBIQUITI NETWORKS”) represents and warrants that the Products furnished hereunder shall be free from defects in material and workmanship for a period of one (1) year from the date of shipment by UBIQUITI NETWORKS under normal use and operation. UBIQUITI NETWORKS sole and exclusive obligation under the foregoing warranty shall be to repair or replace, at its option, any defective Product that fails during the warranty period. The expense of removal and reinstallation of any item is not included in this warranty.

The foregoing warranty is exclusive and in lieu of all other warranties, express or implied, including the implied warranties of merchantability and fitness for a particular purpose and any warranties arising from a course of dealing, usage or trade practice with respect to the products. Repair or replacement in the manner provided herein shall be the sole and exclusive remedy of Buyer for breach of warranty and shall constitute fulfillment of all liabilities of UBIQUITI NETWORKS with respect to the quality and performance of the Products. UBIQUITI NETWORKS reserves the right to inspect all defective Products (which must be returned by Buyer to UBIQUITI NETWORKS factory freight prepaid).

No Products will be accepted for replacement or repair without obtaining a Return Materials Authorization (RMA) number from UBIQUITI NETWORKS. Products returned without an RMA number will not be processed and will be returned to Buyer freight collect. UBIQUITI NETWORKS shall have no obligation to make repairs or replacement necessitated by catastrophe, fault, negligence, misuse, abuse, or accident by Buyer, Buyer’s customers or any other parties. The warranty period of any repaired or replaced. Product shall not extend beyond its original term.

### Warranty Conditions

The foregoing warranty shall apply only if:

- (I) The Product has not been subjected to misuse, neglect or unusual physical, electrical or electromagnetic stress, or some other type of accident.
- (II) No modification, alteration or addition has been made to the Product by persons other than UBIQUITI NETWORKS or UBIQUITI NETWORKS’S authorized representatives or otherwise approved by UBIQUITI NETWORKS.
- (III) The Product has been properly installed and used at all times in accordance, and in all material respects, with the applicable Product documentation.
- (IV) All Ethernet cabling runs use CAT5 (or above) shielded cabling.

### Disclaimer

UBIQUITI NETWORKS does not warrant that the operation of the products is error-free or that operation will be uninterrupted. In no event shall UBIQUITI NETWORKS be responsible for damages or claims of any nature or description relating to system performance, including coverage, buyer’s selection of products for buyer’s application and/or failure of products to meet government or regulatory requirements.

### Returns

In the unlikely event a defect occurs, please work through the dealer or distributor from which this product was purchased.

## Appendix D: Compliance Information

### Installer Compliance Responsibility

Devices must be professionally installed and it is the professional installer's responsibility to make sure the device is operated within local country regulatory requirements.

### FCC

Changes or modifications not expressly approved by the party responsible for compliance could void the user's authority to operate the equipment.

This device complies with Part 15 of the FCC Rules. Operation is subject to the following two conditions:

1. This device may not cause harmful interference, and
2. This device must accept any interference received, including interference that may cause undesired operation.

NOTE: This equipment has been tested and found to comply with the limits for a Class A digital device, pursuant to part 15 of the FCC Rules. These limits are designed to provide reasonable protection against harmful interference when the equipment is operated in a commercial environment. This equipment generates, uses, and can radiate radio frequency energy and, if not installed and used in accordance with the instruction manual, may cause harmful interference to radio communications. Operations of this equipment in a residential area is likely to cause harmful interference in which case the user will be required to correct the interference at his own expense.

For MPE and antenna usage details, please visit our website at

[www.ubnt.com/products](http://www.ubnt.com/products)

### Industry Canada

This Class A digital apparatus complies with Canadian ICES-003.

To reduce potential radio interference to other users, the antenna type and its gain should be so chosen that the equivalent isotropically radiated power (e.i.r.p.) is not more than that permitted for successful communication.

This device complies with Industry Canada licence-exempt RSS standard(s). Operation is subject to the following two conditions:

1. This device may not cause interference, and
2. This device must accept any interference, including interference that may cause undesired operation of the device.

Cet appareil numérique de la classe A est conforme à la norme NMB-003 Canada.

Pour réduire le risque d'interférence aux autres utilisateurs, le type d'antenne et son gain doivent être choisis de façon que la puissance isotrope rayonnée équivalente (PIRE) ne dépasse pas ce qui est nécessaire pour une communication réussie.

Cet appareil est conforme à la norme RSS Industrie Canada exempts de licence norme(s). Son fonctionnement est soumis aux deux conditions suivantes:

1. Cet appareil ne peut pas provoquer d'interférences et
2. Cet appareil doit accepter toute interférence, y compris les interférences qui peuvent causer un mauvais fonctionnement du dispositif.

### RF Exposure Warning

The antennas used for this transmitter must be installed to provide a separation distance of at least 20 cm from all persons and must not be located or operating in conjunction with any other antenna or transmitter.

Les antennes utilisées pour ce transmetteur doivent être installé en considérant une distance de séparation de toute personnes d'au moins 20 cm et ne doivent pas être localisé ou utilisé en conflit avec tout autre antenne ou transmetteur.

### CE Marking

CE marking on this product represents the product is in compliance with all directives that are applicable to it.

### Alert sign! follows CE marking

Alert sign must be indicated if a restriction on use applied to the product and it must follow the CE marking.



## RoHS/WEEE Compliance Statement



### English

European Directive 2002/96/EC requires that the equipment bearing this symbol on the product and/or its packaging must not be disposed of with unsorted municipal waste. The symbol indicates that this product should be disposed of separately from regular household waste streams. It is your responsibility to dispose of this and other electric and electronic equipment via designated collection facilities appointed by the government or local authorities. Correct disposal and recycling will help prevent potential negative consequences to the environment and human health. For more detailed information about the disposal of your old equipment, please contact your local authorities, waste disposal service, or the shop where you purchased the product.

### Deutsch

Die Europäische Richtlinie 2002/96/EC verlangt, dass technische Ausrüstung, die direkt am Gerät und/oder an der Verpackung mit diesem Symbol versehen ist, nicht zusammen mit unsortiertem Gemeindeabfall entsorgt werden darf. Das Symbol weist darauf hin, dass das Produkt von regulärem Haushaltsmüll getrennt entsorgt werden sollte. Es liegt in Ihrer Verantwortung, dieses Gerät und andere elektrische und elektronische Geräte über die dafür zuständigen und von der Regierung oder örtlichen Behörden dazu bestimmten Sammelstellen zu entsorgen. Ordnungsgemäßes Entsorgen und Recyceln trägt dazu bei, potentielle negative Folgen für Umwelt und die menschliche Gesundheit zu vermeiden. Wenn Sie weitere Informationen zur Entsorgung Ihrer Altgeräte benötigen, wenden Sie sich bitte an die örtlichen Behörden oder städtischen Entsorgungsdienste oder an den Händler, bei dem Sie das Produkt erworben haben.

### Español

La Directiva 2002/96/CE de la UE exige que los equipos que lleven este símbolo en el propio aparato y/o en su embalaje no deben eliminarse junto con otros residuos urbanos no seleccionados. El símbolo indica que el producto en cuestión debe separarse de los residuos domésticos convencionales con vistas a su eliminación. Es responsabilidad suya desechar este y cualesquiera otros aparatos eléctricos y electrónicos a través de los puntos de recogida que ponen a su disposición el gobierno y las autoridades locales. Al desechar y reciclar correctamente estos aparatos estará contribuyendo a evitar posibles consecuencias negativas para el medio ambiente y la salud de las personas. Si desea obtener información más detallada sobre la eliminación segura de su aparato usado, consulte a las autoridades locales, al servicio de recogida y eliminación de residuos de su zona o pregunte en la tienda donde adquirió el producto.

### Français

La directive européenne 2002/96/CE exige que l'équipement sur lequel est apposé ce symbole sur le produit et/ou son emballage ne soit pas jeté avec les autres ordures ménagères. Ce symbole indique que le produit doit être éliminé dans un circuit distinct de celui pour les déchets des ménages. Il est de votre responsabilité de jeter ce matériel ainsi que tout autre matériel électrique ou électronique par les moyens de collecte indiqués par le gouvernement et les pouvoirs publics des collectivités territoriales. L'élimination et le recyclage en bonne et due forme ont pour but de lutter contre l'impact néfaste potentiel de ce type de produits sur l'environnement et la santé publique. Pour plus d'informations sur le mode d'élimination de votre ancien équipement, veuillez prendre contact avec les pouvoirs publics locaux, le service de traitement des déchets, ou l'endroit où vous avez acheté le produit.

### Italiano

La direttiva europea 2002/96/EC richiede che le apparecchiature contrassegnate con questo simbolo sul prodotto e/o sull'imballaggio non siano smaltite insieme ai rifiuti urbani non differenziati. Il simbolo indica che questo prodotto non deve essere smaltito insieme ai normali rifiuti domestici. È responsabilità del proprietario smaltire sia questi prodotti sia le altre apparecchiature elettriche ed elettroniche mediante le specifiche strutture di raccolta indicate dal governo o dagli enti pubblici locali. Il corretto smaltimento ed il riciclaggio aiuteranno a prevenire conseguenze potenzialmente negative per l'ambiente e per la salute dell'essere umano. Per ricevere informazioni più dettagliate circa lo smaltimento delle vecchie apparecchiature in Vostro possesso, Vi invitiamo a contattare gli enti pubblici di competenza, il servizio di smaltimento rifiuti o il negozio nel quale avete acquistato il prodotto.

# Appendix E: Declaration of Conformity

Česky [Czech]	UBIQUITI NETWORKS tímto prohlašuje, že tento UBIQUITI NETWORKS device, je ve shodě se základními požadavky a dalšími požadavky nmi ustanovenými směrnicí 1999/5/EC.	Malti [Maltese]	Hawnhekk, UBIQUITI NETWORKS, jiddikjara li dan UBIQUITI NETWORKS device, jikkonforma mal- ti ijjiet essenzjali u ma provvedimenti o rajn relevanti li hemm fid-Dirrettiva 1999/5/EC.
Dansk [Danish]	Undertegnede UBIQUITI NETWORKS erklærer herved, at følgende udstyr UBIQUITI NETWORKS device, overholder de væsentlige krav og øvrige relevante krav i direktiv 1999/5/EF.	Norsk [Norwegian]	UBIQUITI NETWORKS erklærer herved at utstyret UBIQUITI NETWORKS device, er i samsvar med de grunnleggende krav og øvrige relevante krav i direktiv 1999/5/EF.
Nederlands [Dutch]	Hierbij verklaart UBIQUITI NETWORKS dat het toestel UBIQUITI NETWORKS device, in overeenstemming is met de essentiële eisen en de andere relevante bepalingen van richtlijn 1999/5/EG. Bij deze verklaart UBIQUITI NETWORKS dat deze UBIQUITI NETWORKS device, voldoet aan de essentiële eisen en aan de overige relevante bepalingen van Richtlijn 1999/5/EC.	Slovensky [Slovak]	UBIQUITI NETWORKS týmto vyhlasuje, že UBIQUITI NETWORKS device, spĺa základné požiadavky a v etky príslušné ustanovenia Smernice 1999/5/ES.
English	Hereby, UBIQUITI NETWORKS, declares that this UBIQUITI NETWORKS device, is in compliance with the essential requirements and other relevant provisions of Directive 1999/5/EC.	Svenska [Swedish]	Härmed intygar UBIQUITI NETWORKS att denna UBIQUITI NETWORKS device, står i överensstämmelse med de väsentliga egenskapskrav och övriga relevanta bestämmelser som framgår av direktiv 1999/5/EG.
Eesti [Estonian]	Käesolevaga kinnitab UBIQUITI NETWORKS seadme UBIQUITI NETWORKS device, vastavust direktiivi 1999/5/EÜ põhinõuetele ja nimetatud direktiivist tulenevatele teistele asjakohastele sätetele.	Español [Spanish]	Por medio de la presente UBIQUITI NETWORKS declara que el UBIQUITI NETWORKS device, cumple con los requisitos esenciales y cualesquiera otras disposiciones aplicables o exigibles de la Directiva 1999/5/CE.
Suomi [Finnish]	UBIQUITI NETWORKS vakuuttaa täten että UBIQUITI NETWORKS device, tyypinen laite on direktiivin 1999/5/EY oleellisten vaatimusten ja sitä koskevien direktiivin muiden ehtojen mukainen.	Polski [Polish]	Niniejszym, firma UBIQUITI NETWORKS o wiadcza, że produkt serii UBIQUITI NETWORKS device, spełnia zasadnicze wymagania i inne istotne postanowienia Dyrektywy 1999/5/EC.
Français [French]	Par la présente UBIQUITI NETWORKS déclare que l'appareil UBIQUITI NETWORKS device est conforme aux exigences essentielles et aux autres dispositions pertinentes de la directive 1999/5/CE. Par la présente, UBIQUITI NETWORKS déclare que ce UBIQUITI NETWORKS device, est conforme aux exigences essentielles et aux autres dispositions de la directive 1999/5/CE qui lui sont applicables.	Português [Portuguese]	UBIQUITI NETWORKS declara que este UBIQUITI NETWORKS device, está conforme com os requisitos essenciais e outras disposições da Directiva 1999/5/CE.
Deutsch [German]	Hiermit erklärt UBIQUITI NETWORKS, dass sich diese UBIQUITI NETWORKS device, in Übereinstimmung mit den grundlegenden Anforderungen und den anderen relevanten Vorschriften der Richtlinie 1999/5/EG befindet“. (BMW) Hiermit erklärt UBIQUITI NETWORKS die Übereinstimmung des Gerätes UBIQUITI NETWORKS device, mit den grundlegenden Anforderungen und den anderen relevanten Festlegungen der Richtlinie 1999/5/EG. (Wien)	Română [Romanian]	Prin prezenta, UBIQUITI NETWORKS declară că acest dispozitiv UBIQUITI NETWORKS este în conformitate cu cerințele esențiale și alte prevederi relevante ale Directivei 1999/5/CE.
Ελληνική [Greek]	ΜΕ ΤΗΝ ΠΑΡΟΥΣΑ UBIQUITI NETWORKS ΔΗΛΩΝΕΙ ΟΤΙ UBIQUITI NETWORKS device, ΣΥΜΜΟΡΦΩΝΕΤΑΙ ΠΡΟΣ ΤΙΣ ΟΥΣΙΩΔΕΙΣ ΑΠΑΙΤΗΣΕΙΣ ΚΑΙ ΤΙΣ ΛΟΙΠΕΣ ΣΧΕΤΙΚΕΣ ΔΙΑΤΑΞΕΙΣ ΤΗΣ ΟΔΗΓΙΑΣ 1999/5/ΕΚ.		
Magyar [Hungarian]	Alulírott, UBIQUITI NETWORKS nyilatkozom, hogy a UBIQUITI NETWORKS device, megfelel a vonatkozó alapvető követelményeknek és az 1999/5/EC irányelv egyéb előírásainak.		
Íslenska [Icelandic]	Hér með tilkynni UBIQUITI NETWORKS yfir ví a UBIQUITI NETWORKS device, er í samræmi við grunnkröfur og a rar kröfur, sem ger ar eru í tilskipun 1999/5/EC.		
Italiano [Italian]	Con la presente UBIQUITI NETWORKS dichiara che questo UBIQUITI NETWORKS device, è conforme ai requisiti essenziali ed alle altre disposizioni pertinenti stabilite dalla direttiva 1999/5/CE.		
Latviski [Latvian]	Ar o UBIQUITI NETWORKS deklar, ka UBIQUITI NETWORKS device, atbilst Direkt vas 1999/5/EK b tiskaj m pras b m un citiem ar to saist tajiem noteikumiem.		
Lietuviškai [Lithuanian]	UBIQUITI NETWORKS deklaruoja, kad šis UBIQUITI NETWORKS įrenginys atitinka esminius reikalavimus ir kitas 1999/5/EB Direktyvos nuostatas.		

## Appendix F: Contact Information

---

### Ubiquiti Networks Support

Ubiquiti Support Engineers are located around the world and are dedicated to helping customers resolve software, hardware compatibility, or field issues as quickly as possible. We strive to respond to support inquiries within a 24-hour period.

Email: [support@ubnt.com](mailto:support@ubnt.com)

Phone: 408-942-1153 (9 a.m. - 5 p.m. PST)

### Online Resources

Wiki Page: [wiki.ubnt.com](http://wiki.ubnt.com)

Support Forum: [forum.ubnt.com](http://forum.ubnt.com)

Downloads: [downloads.ubnt.com](http://downloads.ubnt.com)



91 E. Tasman Drive  
San Jose, CA 95134

[www.ubnt.com](http://www.ubnt.com)

© 2012 Ubiquiti Networks, Inc. All rights reserved. airFiber™ and Ubiquiti Networks™ are trademarks of Ubiquiti Networks, Inc. WPA™ and WPA2™ are trademarks of the Wi-Fi Alliance.