



## PowerBeam™ ac ISO

5 GHz airMAX® ac Bridge with  
400 mm RF Isolated Reflector

Model: PBE-5AC-400-ISO

QUICK START GUIDE

## Introduction

Thank you for purchasing the Ubiquiti Networks® PowerBeam™ ac. This Quick Start Guide is designed to guide you through installation and includes warranty terms.

## Package Contents



Reflector



Radome



Antenna Feed\*



Rear Housing



Mounting Bracket



Adjustment Bracket



Pole Clamp



Hex Bolts with Washers  
(M8x20, Qty. 4)



Flange Nuts  
(M8, Qty. 2)



Carriage Bolts  
(M8x135, Qty. 2)



Gigabit PoE (24V, 0.5A)  
with Mounting Bracket



Power Cord



Quick Start Guide

\* The *PBE-5AC-400-ISO Antenna Feed* has a thin gray ring around the center of the cap to differentiate it from the *PBE-5AC-300-ISO Antenna Feed*.

TERMS OF USE: Ubiquiti radio devices must be professionally installed. Shielded Ethernet cable and earth grounding must be used as conditions of product warranty. TOUGHcable™ is designed for outdoor installations. It is the customer's responsibility to follow local country regulations, including operation within legal frequency channels, output power, and Dynamic Frequency Selection (DFS) requirements.

# Hardware Overview

## Bottom View

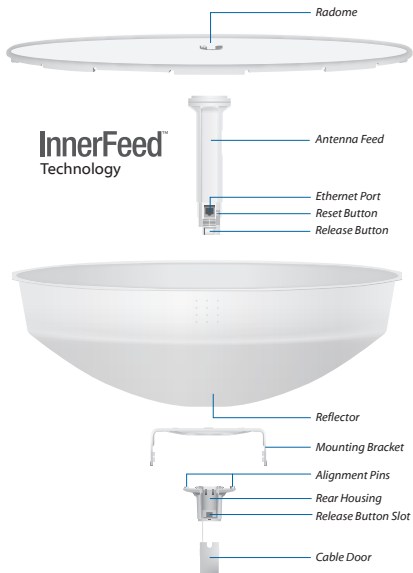





**Reset Button** To reset to factory defaults, press and hold the *Reset* button for more than 10 seconds while the PowerBeam is already powered on. Alternatively, the PowerBeam may be reset remotely via a *Reset* button located on the bottom of the *Gigabit PoE* adapter.

**Release Button** After you assemble the PowerBeam, check the *Release* button; it should be fully engaged in the *Release Button Slot* of the *Rear Housing*. This ensures that the *Antenna Feed* is locked into place. If you need to remove the *Antenna Feed*, you must depress the *Release* button first.

## LEDs



**Signal** In airOS, you can modify the wireless signal strength threshold values for each LED on the *Wireless* tab under *Signal LED Thresholds*. The default values are shown below:

-  LED will light blue when the wireless signal strength is above -65 dBm.
-  LED will light blue when the wireless signal strength is above -73 dBm.
-  LED will light blue when the wireless signal strength is above -80 dBm.
-  LED will light blue when the wireless signal strength is above -94 dBm.

 **Ethernet** The Ethernet LED will light steady blue when an active Ethernet connection is made and flash when there is activity.

 **Power** The Power LED will light blue when the device is connected to a power source.

## Application Examples

The PowerBeam mounted outdoors with the *Reflector* installed provides directional outdoor coverage (gain is reflector-dependent).

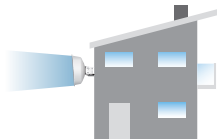

The PowerBeam mounted outdoors without the *Reflector* installed provides outdoor-to-indoor coverage using the 3 dBi *Antenna Feed* only.

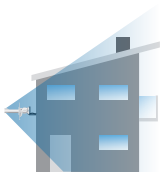

## Installation Requirements

- 13 mm wrench
- Shielded Category 5 (or above) cabling should be used for all wired Ethernet connections and should be grounded through the AC ground of the PoE.

We recommend that you protect your networks from the most brutal environments and devastating ESD attacks with industrial-grade shielded Ethernet cable from Ubiquiti Networks. For more details, visit [www.ubnt.com/toughcable](http://www.ubnt.com/toughcable)

## Installation

1. Align and insert the tabs of the *Mounting Bracket* into the slots of the *Reflector*. Rotate the *Mounting Bracket* counterclockwise until the alignment holes in the dish and bracket align with each other.

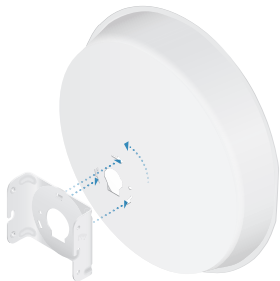

2. Line up the *Alignment Pins* of the *Rear Housing* with the alignment holes of the *Mounting Bracket*. Push the *Rear Housing* into the *Mounting Bracket*.



3. View the *Reflector* from the front. Ensure that the three hooks (indicated below) of the *Rear Housing* are fully engaged with the inner wall of the *Reflector* and locked into place.

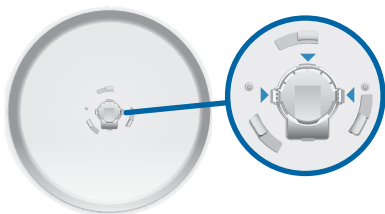

**!** **Important:** Before proceeding, lightly pull the *Rear Housing* to confirm that it is locked into place.

4. Push in the sides of the *Cable Door* and detach it from the *Rear Housing*.



5. Attach the *Antenna Feed*.

- a. Insert the *Antenna Feed* into the *Rear Housing*, and push until it locks into place with a click.
- b. Lightly pull the *Antenna Feed* to ensure that it is locked into place and the *Release Button* is fully engaged.

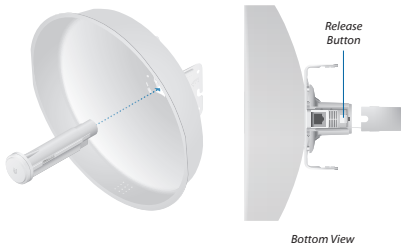

6. Connect an Ethernet cable to the *Ethernet Port* of the *Antenna Feed*. Then re-attach the *Cable Door* to the *Rear Housing*.





7. Attach the *Pole Clamp* to the *Adjustment Bracket*.
- Hold the *Adjustment Bracket* with the clamps facing you and the *Elevation Indicators* towards the top.
  - Insert the *Carriage Bolts* through the holes of the *Adjustment Bracket*.
  - Slide the hole of the *Pole Clamp* over one bolt of the *Adjustment Bracket*.
  - Place one *Flange Nut* on each bolt.

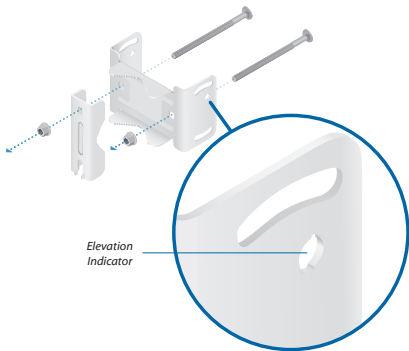

8. Insert the *Pivot Pins* on the inside of the *Adjustment Bracket* into the *Mounting Bracket Slots*.

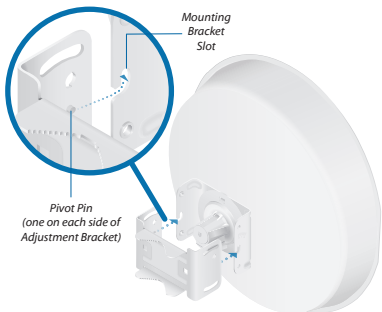

9. Secure the *Adjustment Bracket* to the *Mounting Bracket* using the four *Hex Bolts with Washers*.

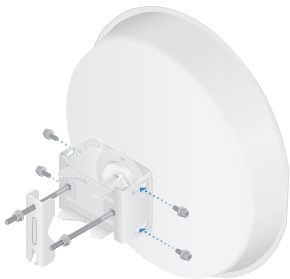

10. Position the reflector assembly on the pole and secure it.
- Place the *Adjustment Bracket* against the pole.
  - Slide the slot of the *Pole Clamp* over the *Carriage Bolt*.
  - Tighten the *Flange Nuts* of the bolts to 25 N-m to secure the antenna to the pole.



**Note:** The mounting assembly can accommodate a  $\text{Ø } 40 - 80 \text{ mm}$  pole.

11. Align the *Notch* on the *Reflector* with the *Arrow* at the top of the *Radome*. Guide the *Radome's* side and top tabs over the *Reflector* rim and slide the *Radome* down onto the *Reflector*.



12. Snap the bottom three tabs of the *Radome* over the *Reflector* rim.



13. Adjust the elevation angle.

- Loosen the four *Hex Bolts* on both sides of the antenna.
- Pivot the antenna until the *Elevation Indicator* shows the desired elevation angle.
- Tighten the four *Hex Bolts*.



14. Connect the Ethernet cable from the PowerBeam's *Ethernet* port to the **POE** port of the *Gigabit PoE* adapter.
15. Connect an Ethernet cable from your LAN to the adapter's **LAN** port.
16. Connect the *Power Cord* to the adapter's power port. Connect the other end of the *Power Cord* to a power outlet.



### Mounting the PoE Adapter (Optional)

1. Remove the *PoE Mounting Bracket* from the adapter, place the bracket at the desired location, and mark the two holes.
2. Pre-drill the holes if necessary, and secure the bracket using two fasteners (not included).
3. Align the adapter's slots with the tabs of the *PoE Mounting Bracket*, and then slide the adapter down.



640-00193-02

## Accessing airOS

Verify connectivity in the airOS Configuration Interface.

1. Make sure that your host system is connected via Ethernet to the PowerBeam.
2. Configure the Ethernet adapter on your host system with a static IP address on the 192.168.1.x subnet.
3. Launch your web browser and type **https://192.168.1.20** in the address field. Press **enter** (PC) or **return** (Mac).

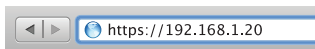

4. The login screen will appear. Enter **ubnt** in the *Username* and *Password* fields. Select your *Country* and *Language*. You must agree to the *Terms of Use* to use the product. Click **Login**.

A screenshot of the login interface for a PowerBeam 5AC 400 device. The title is "PowerBeam 5AC 400" and the subtitle is "Please login to manage your wireless device." The interface is divided into two columns. The left column contains four input fields: "Username" (with a text input box), "Password" (with a text input box), "Country" (with a dropdown menu showing "Select Your Country"), and "Language" (with a dropdown menu showing "English"). The right column contains a "TERMS OF USE" section with a paragraph of text and a link for "UBIQUITI FIRMWARE LICENSE AGREEMENT". At the bottom left, there is a checkbox labeled "I agree to these TERMS OF USE and the UBIQUITI FIRMWARE LICENSE AGREEMENT". At the bottom right, there is a green "LOGIN" button.

**Note:** For the *Country* setting, U.S. product versions are restricted to a choice of Canada, Puerto Rico, or the U.S. to ensure compliance with FCC/IC regulations.

The airOS Configuration Interface will appear, allowing you to customize your settings as needed. For additional details on the airOS Configuration Interface, refer to the User Guide available at [documentation.ubnt.com/airmax](https://documentation.ubnt.com/airmax)

## Installer Compliance Responsibility

Devices must be professionally installed and it is the professional installer's responsibility to make sure the device is operated within local country regulatory requirements.

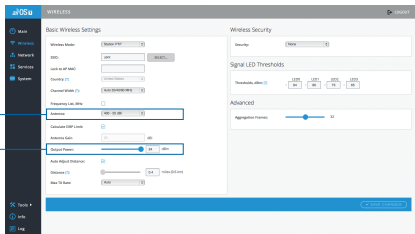

Since Ubiquiti Networks equipment can be paired with a variety of antennas and cables, the *Antenna* and *Output Power* fields are provided to the professional installer to assist in meeting regulatory requirements.



## Specifications

PBE-5AC-400-ISO	
Dimensions with Radome	459 x 459 x 261 mm (18.07 x 18.07 x 10.28")
Weight (Mount Included)	3.22 kg (7.10 lb)
Operating Frequency	Worldwide: 5150 - 5875 MHz USA: 5725 - 5850 MHz
Gain	25 dBi
Networking Interface	(1) 10/100/1000 Ethernet Port
Enclosure	Outdoor UV Stabilized Plastic
Max. Power Consumption	8.5W
Power Supply	24V, 0.5A Gigabit PoE Adapter (Included)
Power Method	Passive PoE (Pairs 4, 5+; 7, 8 Return)
Wind Survivability	200 km/h (125 mph)
Wind Loading	390 N @ 200 km/h (88 lbf @ 125 mph)
Certifications	CE, FCC, IC
Mounting	Pole Mounting Kit Included
Operating Temperature	-40 to 70° C (-40 to 158° F)
Operating Humidity	5 to 95% Noncondensing
Shock and Vibrations	ETSI300-019-1.4

## Safety Notices

1. Read, follow, and keep these instructions.
2. Heed all warnings.
3. Only use attachments/accessories specified by the manufacturer.



**WARNING:** Do not use this product in location that can be submerged by water.



**WARNING:** Avoid using this product during an electrical storm. There may be a remote risk of electric shock from lightning.

## Electrical Safety Information

1. Compliance is required with respect to voltage, frequency, and current requirements indicated on the manufacturer's label. Connection to a different power source than those specified may result in improper operation, damage to the equipment or pose a fire hazard if the limitations are not followed.
2. There are no operator serviceable parts inside this equipment. Service should be provided only by a qualified service technician.
3. This equipment is provided with a detachable power cord which has an integral safety ground wire intended for connection to a grounded safety outlet.
  - a. Do not substitute the power cord with one that is not the provided approved type. Never use an adapter plug to connect to a 2-wire outlet as this will defeat the continuity of the grounding wire.
  - b. The equipment requires the use of the ground wire as a part of the safety certification, modification or misuse can provide a shock hazard that can result in serious injury or death.
  - c. Contact a qualified electrician or the manufacturer if there are questions about the installation prior to connecting the equipment.
  - d. Protective earthing is provided by Listed AC adapter. Building installation shall provide appropriate short-circuit backup protection.
  - e. Protective bonding must be installed in accordance with local national wiring rules and regulations.

## Limited Warranty

UBIQUITI NETWORKS, Inc (“UBIQUITI NETWORKS”) warrants that the product(s) furnished hereunder (the “Product(s)”) shall be free from defects in material and workmanship for a period of one (1) year from the date of shipment by UBIQUITI NETWORKS under normal use and operation. UBIQUITI NETWORKS’ sole and exclusive obligation and liability under the foregoing warranty shall be for UBIQUITI NETWORKS, at its discretion, to repair or replace any Product that fails to conform to the above warranty during the above warranty period. The expense of removal and reinstallation of any Product is not included in this warranty. The warranty period of any repaired or replaced Product shall not extend beyond its original term.

## Warranty Conditions

The above warranty does not apply if the Product:

- (I) has been modified and/or altered, or an addition made thereto, except by Ubiquiti Networks, or Ubiquiti Networks’ authorized representatives, or as approved by Ubiquiti Networks in writing;
- (II) has been painted, rebranded or physically modified in any way;
- (III) has been damaged due to errors or defects in cabling;
- (IV) has been subjected to misuse, abuse, negligence, abnormal physical, electromagnetic or electrical stress, including lightning strikes, or accident;
- (V) has been damaged or impaired as a result of using third party firmware;
- (VI) has no original Ubiquiti MAC label, or is missing any other original Ubiquiti label(s); or
- (VII) has not been received by Ubiquiti within 30 days of issuance of the RMA.

In addition, the above warranty shall apply only if: the product has been properly installed and used at all times in accordance, and in all material respects, with the applicable Product documentation; all Ethernet cabling runs use CAT5 (or above), and for outdoor installations, shielded Ethernet cabling is used, and for indoor installations, indoor cabling requirements are followed.

## Returns

No Products will be accepted for replacement or repair without obtaining a Return Materials Authorization (RMA) number from UBIQUITI NETWORKS during the warranty period, and the Products being received at UBIQUITI NETWORKS’ facility freight prepaid in accordance with the RMA process of UBIQUITI NETWORKS. Products returned without an RMA number will not be processed and will be returned freight collect or subject to disposal. Information on the RMA process and obtaining an RMA number can be found at: [www.ubnt.com/support/warranty](http://www.ubnt.com/support/warranty).

## Disclaimer

EXCEPT FOR ANY EXPRESS WARRANTIES PROVIDED HEREIN, UBIQUITI NETWORKS, ITS AFFILIATES, AND ITS AND THEIR THIRD PARTY DATA, SERVICE, SOFTWARE AND HARDWARE PROVIDERS HEREBY DISCLAIM AND MAKE NO OTHER REPRESENTATION OR WARRANTY OF ANY KIND, EXPRESS, IMPLIED OR STATUTORY, INCLUDING, BUT NOT LIMITED TO, REPRESENTATIONS, GUARANTEES, OR WARRANTIES OF MERCHANTABILITY, ACCURACY, QUALITY OF SERVICE OR RESULTS, AVAILABILITY, SATISFACTORY QUALITY, LACK OF VIRUSES, QUIET ENJOYMENT, FITNESS FOR A PARTICULAR PURPOSE AND NON-INFRINGEMENT AND ANY WARRANTIES ARISING FROM ANY COURSE OF DEALING, USAGE OR TRADE PRACTICE IN CONNECTION WITH SUCH PRODUCTS AND SERVICES. BUYER ACKNOWLEDGES THAT NEITHER UBIQUITI NETWORKS NOR ITS THIRD PARTY PROVIDERS CONTROL BUYER'S EQUIPMENT OR THE TRANSFER OF DATA OVER COMMUNICATIONS FACILITIES, INCLUDING THE INTERNET, AND THAT THE PRODUCTS AND SERVICES MAY BE SUBJECT TO LIMITATIONS, INTERRUPTIONS, DELAYS, CANCELLATIONS AND OTHER PROBLEMS INHERENT IN THE USE OF COMMUNICATIONS FACILITIES. UBIQUITI NETWORKS, ITS AFFILIATES AND ITS AND THEIR THIRD PARTY PROVIDERS ARE NOT RESPONSIBLE FOR ANY INTERRUPTIONS, DELAYS, CANCELLATIONS, DELIVERY FAILURES, DATA LOSS, CONTENT CORRUPTION, PACKET LOSS, OR OTHER DAMAGE RESULTING FROM ANY OF THE FOREGOING. In addition, UBIQUITI NETWORKS does not warrant that the operation of the Products will be error-free or that operation will be uninterrupted. In no event shall UBIQUITI NETWORKS be responsible for damages or claims of any nature or description relating to system performance, including coverage, buyer's selection of products (including the Products) for buyer's application and/or failure of products (including the Products) to meet government or regulatory requirements.

## Limitation of Liability

EXCEPT TO THE EXTENT PROHIBITED BY LOCAL LAW, IN NO EVENT WILL UBIQUITI OR ITS SUBSIDIARIES, AFFILIATES OR SUPPLIERS BE LIABLE FOR DIRECT, SPECIAL, INCIDENTAL, CONSEQUENTIAL OR OTHER DAMAGES (INCLUDING LOST PROFIT, LOST DATA, OR DOWNTIME COSTS), ARISING OUT OF THE USE, INABILITY TO USE, OR THE RESULTS OF USE OF THE PRODUCT, WHETHER BASED IN WARRANTY, CONTRACT, TORT OR OTHER LEGAL THEORY, AND WHETHER OR NOT ADVISED OF THE POSSIBILITY OF SUCH DAMAGES.

## Note

Some countries, states and provinces do not allow exclusions of implied warranties or conditions, so the above exclusion may not apply to you. You may have other rights that vary from country to country, state to state, or province to province. Some countries, states and provinces do not allow the exclusion or limitation of liability for incidental or consequential damages, so the above limitation may not apply to you. EXCEPT TO THE EXTENT ALLOWED BY LOCAL LAW, THESE WARRANTY TERMS DO NOT EXCLUDE, RESTRICT OR MODIFY, AND ARE IN ADDITION TO, THE MANDATORY STATUTORY RIGHTS APPLICABLE TO THE LICENSE OF ANY SOFTWARE (EMBEDDED IN THE PRODUCT) TO YOU. The United Nations Convention on Contracts for the International Sale of Goods shall not apply to any transactions regarding the sale of the Products.

## Compliance

### FCC

Changes or modifications not expressly approved by the party responsible for compliance could void the user's authority to operate the equipment.

This device complies with Part 15 of the FCC Rules. Operation is subject to the following two conditions.

1. This device may not cause harmful interference, and
2. This device must accept any interference received, including interference that may cause undesired operation.

This equipment has been tested and found to comply with the limits for a Class B digital device, pursuant to Part 15 of the FCC Rules. These limits are designed to provide reasonable protection against harmful interference in a residential installation. This equipment generates, uses and can radiate radio frequency energy and, if not installed and used in accordance with the instructions, may cause harmful interference to radio communications. However, there is no guarantee that interference will not occur in a particular installation. If this equipment does cause harmful interference to radio or television reception, which can be determined by turning the equipment off and on, the user is encouraged to try to correct the interference by one or more of the following measures:

- Reorient or relocate the receiving antenna.
- Increase the separation between the equipment and receiver.
- Connect the equipment into an outlet on a circuit different from that to which the receiver is connected.
- Consult the dealer or an experienced radio/TV technician for help.

Operations of this equipment in a residential area is likely to cause harmful interference in which case the user will be required to correct the interference at his own expense.

This radio transmitter FCC ID: SWX-NBEM5AC has been approved by FCC to operate with the antenna types listed below with the maximum permissible gain and required antenna impedance for each antenna type indicated. Antenna types not included in this list, having a gain greater than the maximum gain indicated for that type, are strictly prohibited for use with this device.

Antenna Information: Dish antenna, Gain: 25 dBi

## Industry Canada

### CAN ICES-3(B)/NMB-3(B)

To reduce potential radio interference to other users, the antenna type and its gain should be so chosen that the equivalent isotropically radiated power (e.i.r.p.) is not more than that permitted for successful communication.

This device complies with Industry Canada licence-exempt RSS standard(s). Operation is subject to the following two conditions:

1. This device may not cause interference, and
2. This device must accept any interference, including interference that may cause undesired operation of the device.

This radio transmitter (IC: 6545A-NBEM5AC) has been approved by Industry Canada to operate with the antenna types listed below with the maximum permissible gain and required antenna impedance for each antenna type indicated. Antenna types not included in this list, having a gain greater than the maximum gain indicated for that type, are strictly prohibited for use with this device.

Antenna Information: Dish antenna, Gain: 25 dBi

### CAN ICES-3(B)/NMB-3(B)

Pour réduire le risque d'interférence aux autres utilisateurs, le type d'antenne et son gain doivent être choisis de façon que la puissance isotrope rayonnée équivalente (PIRE) ne dépasse pas ce qui est nécessaire pour une communication réussie.

Cet appareil est conforme à la norme RSS Industrie Canada exempts de licence norme(s). Son fonctionnement est soumis aux deux conditions suivantes:

1. Cet appareil ne peut pas provoquer d'interférences et
2. Cet appareil doit accepter toute interférence, y compris les interférences qui peuvent causer un mauvais fonctionnement du dispositif.

Cet émetteur radio (IC: 6545A-NBEM5AC) a été approuvée par Industrie Canada pour l'exploitation avec l'antenne types énumérés ci-dessous avec le gain maximal admissible et requis l'impédance de l'antenne pour chaque type d'antenne indiqué. Types d'antenne non inclus dans cette liste, ayant un gain supérieur au gain maximal indiqué pour ce type, sont strictement interdits pour une utilisation avec cet appareil. Immédiatement suite à la remarque, le fabricant doit fournir une liste de tous les types d'antenne approuvé pour une utilisation avec l'émetteur, ce qui indique le gain maximal d'antenne permis (en dBi) et requis d'impédance pour chacun.

Informations d'antenne: Antenne parabolique, Gain: 25 dBi

## RF Exposure Warning

The antennas used for this transmitter must be installed to provide a separation distance of at least 20 cm from all persons and must not be located or operating in conjunction with any other antenna or transmitter.

Les antennes utilisées pour ce transmetteur doivent être installé en considérant une distance de séparation de toute personnes d'au moins 20 cm et ne doivent pas être localisé ou utilisé en conflit avec tout autre antenne ou transmetteur.

## CE Marking

CE marking on this product represents the product is in compliance with all directives that are applicable to it.

## Alert Sign (!) Follows CE Marking

Alert sign must be indicated if a restriction on use applied to the product and it must follow the CE marking.



## RoHS/WEEE Compliance Statement



### English

European Directive 2002/96/EC requires that the equipment bearing this symbol on the product and/or its packaging must not be disposed of with unsorted municipal waste. The symbol indicates that this product should be disposed of separately from regular household waste streams. It is your responsibility to dispose of this and other electric and electronic equipment via designated collection facilities appointed by the government or local authorities. Correct disposal and recycling will help prevent potential negative consequences to the environment and human health. For more detailed information about the disposal of your old equipment, please contact your local authorities, waste disposal service, or the shop where you purchased the product.

### Deutsch

Die Europäische Richtlinie 2002/96/EC verlangt, dass technische Ausrüstung, die direkt am Gerät und/oder an der Verpackung mit diesem Symbol versehen ist, nicht zusammen mit unsortiertem Gemeindeabfall entsorgt werden darf. Das Symbol weist darauf hin, dass das Produkt von regulärem Haushaltsmüll getrennt entsorgt werden sollte. Es liegt in Ihrer Verantwortung, dieses Gerät und andere elektrische und elektronische Geräte über die dafür zuständigen und von der Regierung oder örtlichen Behörden dazu bestimmten Sammelstellen zu entsorgen. Ordnungsgemäßes Entsorgen und Recyceln trägt dazu bei, potentielle negative Folgen für Umwelt und die menschliche Gesundheit zu vermeiden. Wenn Sie weitere Informationen zur Entsorgung Ihrer Altgeräte benötigen, wenden Sie sich bitte an die örtlichen Behörden oder städtischen Entsorgungsdienste oder an den Händler, bei dem Sie das Produkt erworben haben.



## Español

La Directiva 2002/96/CE de la UE exige que los equipos que lleven este símbolo en el propio aparato y/o en su embalaje no deben eliminarse junto con otros residuos urbanos no seleccionados. El símbolo indica que el producto en cuestión debe separarse de los residuos domésticos convencionales con vistas a su eliminación. Es responsabilidad suya desechar este y cualesquiera otros aparatos eléctricos y electrónicos a través de los puntos de recogida que ponen a su disposición el gobierno y las autoridades locales. Al desechar y reciclar correctamente estos aparatos estará contribuyendo a evitar posibles consecuencias negativas para el medio ambiente y la salud de las personas. Si desea obtener información más detallada sobre la eliminación segura de su aparato usado, consulte a las autoridades locales, al servicio de recogida y eliminación de residuos de su zona o pregunte en la tienda donde adquirió el producto.

## Français

La directive européenne 2002/96/CE exige que l'équipement sur lequel est apposé ce symbole sur le produit et/ou son emballage ne soit pas jeté avec les autres ordures ménagères. Ce symbole indique que le produit doit être éliminé dans un circuit distinct de celui pour les déchets des ménages. Il est de votre responsabilité de jeter ce matériel ainsi que tout autre matériel électrique ou électronique par les moyens de collecte indiqués par le gouvernement et les pouvoirs publics des collectivités territoriales. L'élimination et le recyclage en bonne et due forme ont pour but de lutter contre l'impact néfaste potentiel de ce type de produits sur l'environnement et la santé publique. Pour plus d'informations sur le mode d'élimination de votre ancien équipement, veuillez prendre contact avec les pouvoirs publics locaux, le service de traitement des déchets, ou l'endroit où vous avez acheté le produit.

## Italiano

La direttiva europea 2002/96/EC richiede che le apparecchiature contrassegnate con questo simbolo sul prodotto e/o sull'imballaggio non siano smaltite insieme ai rifiuti urbani non differenziati. Il simbolo indica che questo prodotto non deve essere smaltito insieme ai normali rifiuti domestici. È responsabilità del proprietario smaltire sia questi prodotti sia le altre apparecchiature elettriche ed elettroniche mediante le specifiche strutture di raccolta indicate dal governo o dagli enti pubblici locali. Il corretto smaltimento ed il riciclaggio aiuteranno a prevenire conseguenze potenzialmente negative per l'ambiente e per la salute dell'essere umano. Per ricevere informazioni più dettagliate circa lo smaltimento delle vecchie apparecchiature in Vostro possesso, Vi invitiamo a contattare gli enti pubblici di competenza, il servizio di smaltimento rifiuti o il negozio nel quale avete acquistato il prodotto.

## Declaration of Conformity

Česky [Czech]	UBIQUITI NETWORKS tímto prohlašuje, že toto UBIQUITI NETWORKS zařízení, je ve shod se základními požadavky a dalšími příslušnými ustanoveními směrnice 1999/5/ES.
Dansk [Danish]	Hermed, UBIQUITI NETWORKS, erklærer at denne UBIQUITI NETWORKS enhed, er i overensstemmelse med de væsentlige krav og øvrige relevante krav i direktiv 1999/5/EF.
Nederlands [Dutch]	Hierbij verklaart UBIQUITI NETWORKS, dat deze UBIQUITI NETWORKS apparaat, in overeenstemming is met de essentiële eisen en de andere relevante bepalingen van richtlijn 1999/5/EC.
English	Hereby, UBIQUITI NETWORKS, declares that this UBIQUITI NETWORKS device, is in compliance with the essential requirements and other relevant provisions of Directive 1999/5/EC.
Eesti [Estonian]	Käesolevaga UBIQUITI NETWORKS kinnitab, et antud UBIQUITI NETWORKS seade, on vastavus oluliste nõuetele ja teistele asjakohastele sätetele direktiivi 1999/5/EÜ.
Suomi [Finnish]	Täten UBIQUITI NETWORKS vakuuttaa, että tämä UBIQUITI NETWORKS laite, on yhdenmukainen olennaisten vaatimusten ja muiden sitä koskevien direktiivin 1999/5/EY.
Français [French]	Par la présente UBIQUITI NETWORKS déclare que l'appareil UBIQUITI NETWORKS, est conforme aux exigences essentielles et aux autres dispositions pertinentes de la directive 1999/5/CE.
Deutsch [German]	Hiermit erklärt UBIQUITI NETWORKS, dass sich dieses UBIQUITI NETWORKS Gerät, in Übereinstimmung mit den grundlegenden Anforderungen und den anderen relevanten Vorschriften der Richtlinie 1999/5/EG befindet.
Ελληνική [Greek]	Δια του παρόντος, UBIQUITI NETWORKS, δηλώνει ότι αυτή η συσκευή UBIQUITI NETWORKS, είναι σε συμμόρφωση με τις βασικές απαιτήσεις και τις λοιπές σχετικές διατάξεις της οδηγίας 1995/5/EK.
Magyar [Hungarian]	Ezennel UBIQUITI NETWORKS kijelenti, hogy ez a UBIQUITI NETWORKS készülék megfelel az alapvető követelményeknek és más vonatkozó 1999/5/EK irányelv rendelkezéseit.
Íslenska [Icelandic]	Hér, UBIQUITI NETWORKS, því yfir að þetta UBIQUITI NETWORKS tæki er í samræmi við grunnkröfur og önnur viðeigandi ákvæði tilskipun 1999/5/EC.
Italiano [Italian]	Con la presente, UBIQUITI NETWORKS, dichiara che questo dispositivo UBIQUITI NETWORKS, è conforme ai requisiti essenziali ed alle altre disposizioni pertinenti della direttiva 1999/5/CE.
Latviski [Latvian]	Ar šo, UBIQUITI NETWORKS, deklarē, ka UBIQUITI NETWORKS ierīce, ir saskaņā ar būtiskajām prasībām un citiem attiecīgiem noteikumiem Direktīvā 1999/5/EK.

Lietuviškai [Lithuanian]	UBIQUITI NETWORKS deklaruoja, kad šis UBIQUITI NETWORKS įrenginys atitinka esminius reikalavimus ir kitas 1999/5/EB Direktyvos nuostatas.
Malti [Maltese]	Hawnhekk, UBIQUITI NETWORKS, tiddikjara li dan il-mezz UBIQUITI NETWORKS huwa konformi mar-rekwiżiti essenzjali u dispożizzjonijiet rilevanti oħrajn ta 'Direttiva 1999/5/EC.
Norsk [Norwegian]	Herved UBIQUITI NETWORKS, erklærer at denne UBIQUITI NETWORKS enheten, er i samsvar med de grunnleggende kravene og andre relevante bestemmelser i direktiv 1999/5/EF.
Slovensky [Slovak]	Týmto UBIQUITI NETWORKS, prehlasuje, že toto UBIQUITI NETWORKS zariadenie, je v súlade so základnými požiadavkami a ďalšími relevantnými ustanoveniami smernice 1999/5/ES.
Svenska [Swedish]	Härmed UBIQUITI NETWORKS, intygar att denna UBIQUITI NETWORKS enhet är i överensstämmelse med de väsentliga egenskapskrav och övriga relevanta bestämmelser som framgår av direktiv 1999/5/EG.
Español [Spanish]	Por medio de la presente UBIQUITI NETWORKS declara que este dispositivo UBIQUITI NETWORKS, cumple con los requisitos esenciales y cualesquiera otras disposiciones aplicables o exigibles de la Directiva 1999/5/CE.
Polski [Polish]	Niniejszym, Ubiquiti Networks, oświadcza, że urządzenie UBIQUITI NETWORKS, jest zgodny z zasadniczymi wymaganiami oraz pozostałymi stosownymi postanowieniami Dyrektywy 1999/5/EC.
Português [Portuguese]	UBIQUITI NETWORKS declara que este dispositivo UBIQUITI NETWORKS, está conforme com os requisitos essenciais e outras disposições da Directiva 1999/5/CE.
Română [Romanian]	Prin prezenta, UBIQUITI NETWORKS declară că acest dispozitiv UBIQUITI NETWORKS este în conformitate cu cerințele esențiale și alte prevederi relevante ale Directivei 1999/5/CE.

## Online Resources

Support [support.ubnt.com](http://support.ubnt.com)

Community [community.ubnt.com](http://community.ubnt.com)

Downloads [downloads.ubnt.com](http://downloads.ubnt.com)



[www.ubnt.com](http://www.ubnt.com)