

1 Hardware Installation

Default wireless network names (SSIDs):
2.4GHz Wi-Fi: TOTOLINK_N210RE

LEDs, Interfaces, Buttons

LEDs	Status	Description
CPU LED	On	The router is booting or WPS is enabled.
	Blink slowly	The router finishes the booting process and is working normally.
	Blink quickly	When the reset process is being proceeded.
	Off	The power is off.

Interfaces and Buttons	Description
Power Connector	Connect to an electrical outlet with the supplied power adapter.
WAN Connector	Connect to a Modem or the in-wall wired Ethernet jack.
LAN 1 through 2 Connectors	Connect to the PCs.
RST/WPS Button	Enable WPS function: when the router is powered on, press and hold this button for 1 second until the panel CPU LED turns solid on. Reset to factory defaults: when the router is powered on, press and hold this button for 5 seconds or more until the CPU LED blinks quickly.

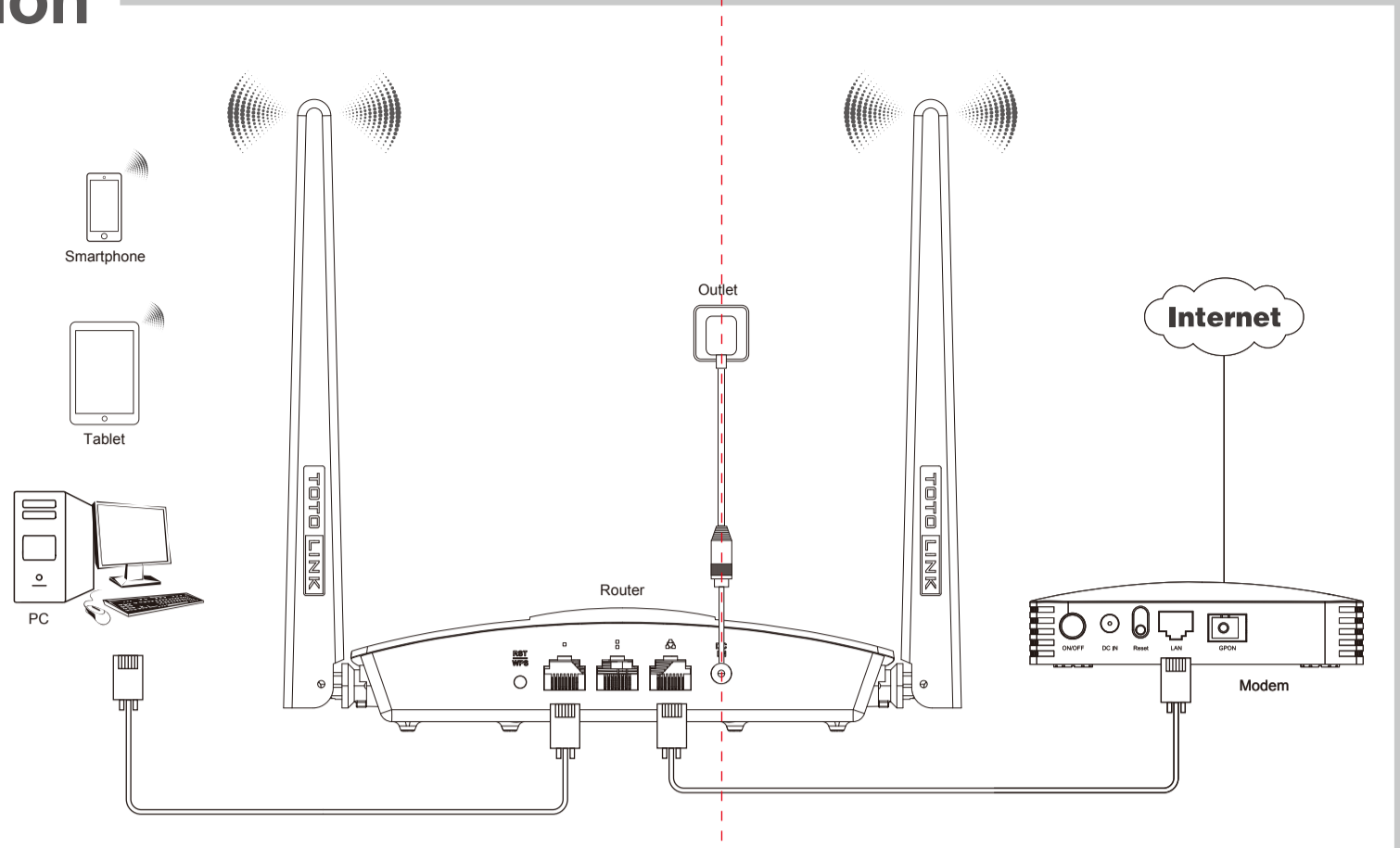

2 Setup via Smartphone

1 Log in to the router

- A. Make sure that the router has power.
- B. Use your smartphone to find and select **TOTOLINK_N210RE**

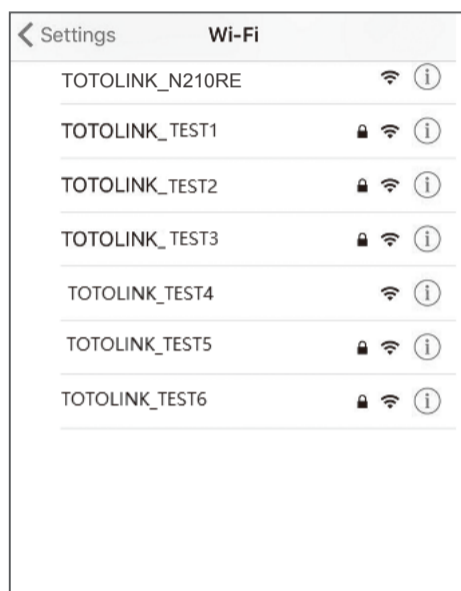

- C. Launch a web browser from your smartphone.
- D. In the address bar, type the router's IP address **192.168.0.1**, and then touch **Enter**. Enter the de-fault user name **admin** and password **admin**, and then touch **LOGIN**.



2 Touch Quick Setup to set up your router.

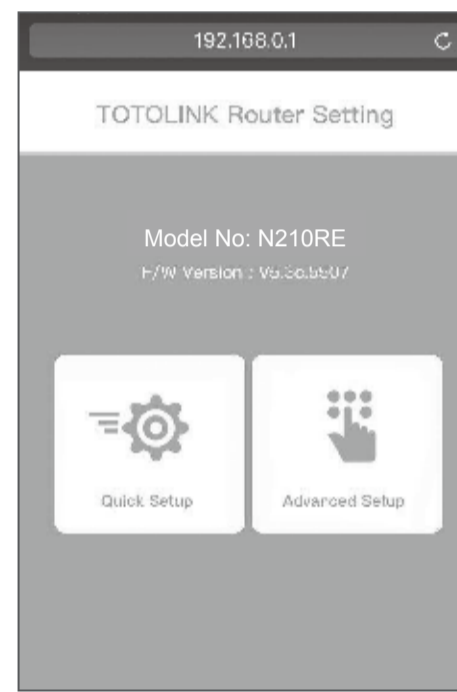

- A. Select a WAN connection type, for example, PPPoE. Enter the user name and password provided by your Internet service provider, and then touch **Next**.

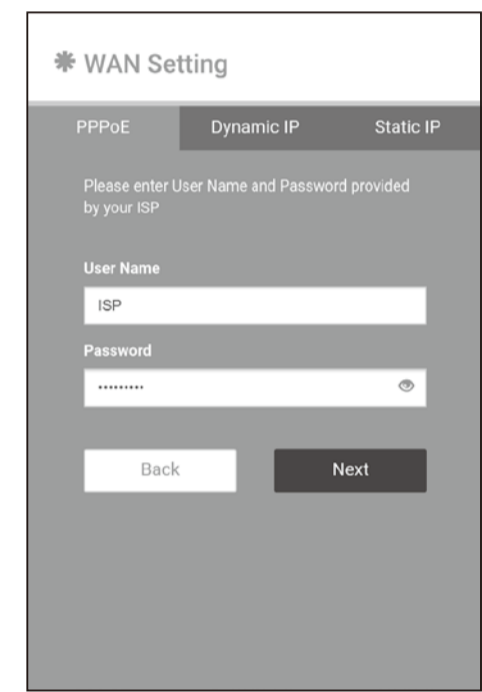

2 Setup via Smartphone

- B. Configure the SSIDs and passwords in 5G and 2.4G Wi-Fi, and then touch **Finish**.

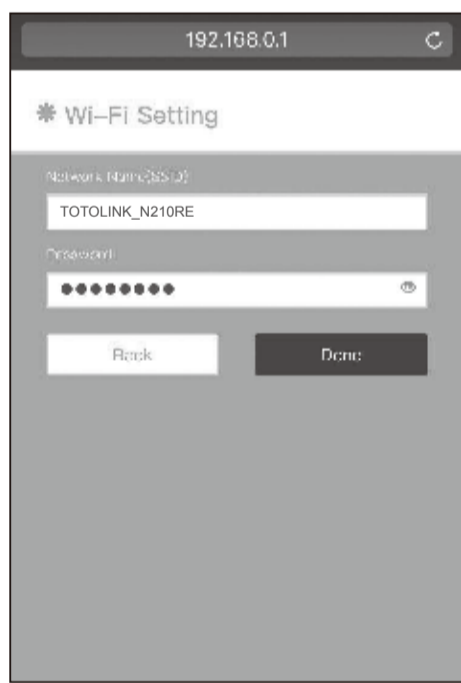

- C. Please wait while the settings are being applied.

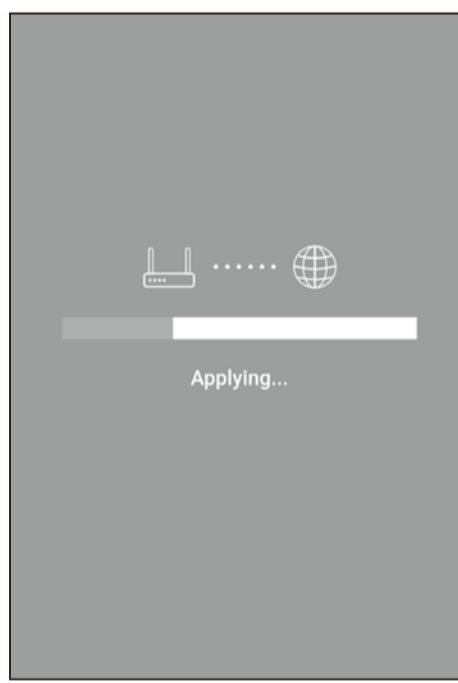

- D. When the message **Setup Successfully** appears, it means that wireless setup is complete.

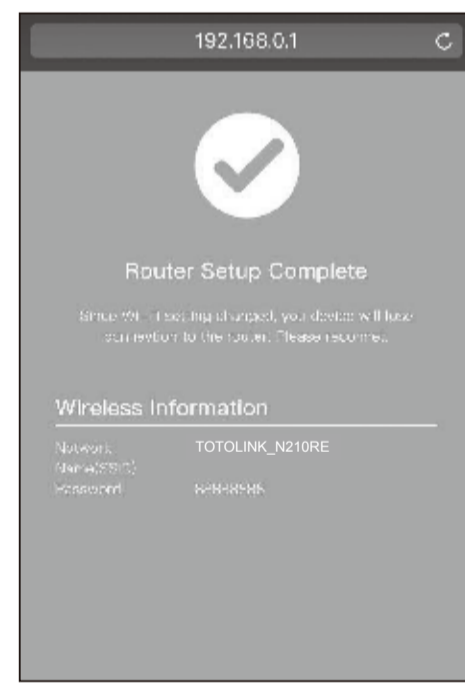

4 FAQ (Frequently Asked Questions)

- 1 What can I do if the login page does not appear?**
1. Check your computer's IP address, make sure it is set to "Obtain an IP address automatically". Steps: right click **Network**—**Properties**—**Change adapter settings**—**Local Area Connection**—**Properties**—**Internet Protocol Version 4(TCP/IPv4)**.
2. Make sure you enter the correct default access: **192.168.0.1**. Try again.
3. Use another web browser and try again.
4. Reboot your router and try again.
- 2 What can I do if I cannot access the Internet?**
1. Check the Internet status by connecting a computer directly to the modem via Ethernet cable. If it is not working properly, contact your Internet Service Provider.
2. Setup your router again according to part **2 Configure the Router**.
3. Reboot your cable modem (if have) and router, then try again.
- 3 How to reset the router to factory default Settings?**
Keep the router powered on, press and hold the RST/WPS button for 5 seconds or more until the front panel CPU LED blinks quickly. It will restore to factory default settings.

3 Easy Setup via PC

- 1 Run any Web browser. Enter **192.168.0.1** in the address bar.
- 2 Enter **admin** for both **User Name** and **Password**, then click **LOGIN**.

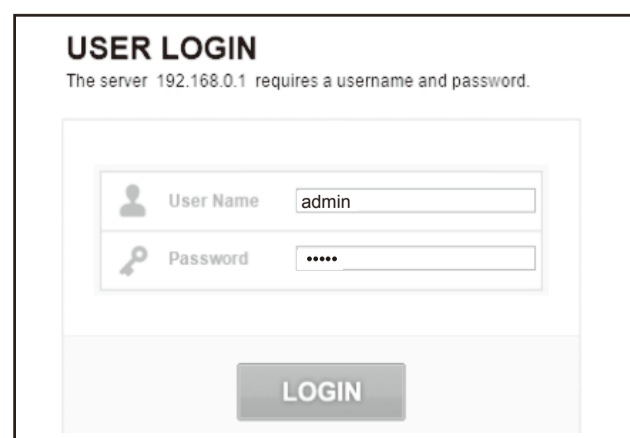

- 3 Now you can see the **Easy Setup** page. All basic settings could be done here, including **Internet Settings** and **2.4GHz Wireless Settings**.

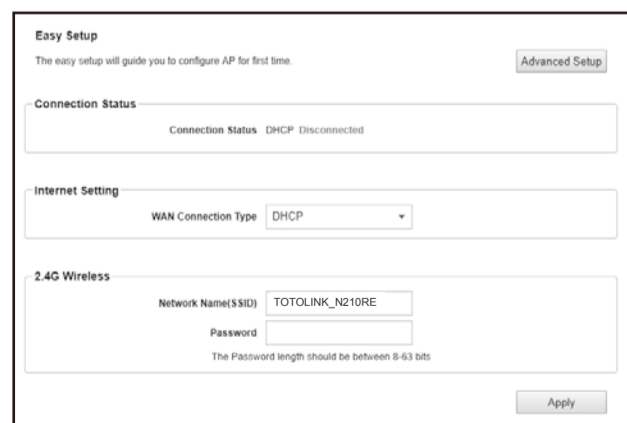

NOTE:
After you set the Key, please remember your SSID and the Key to connect with your wireless LAN.
WPS: press for about 1-3 seconds, the system LED indicator keep solid light, it means WPS working.
RST: press for about 5-8 seconds, the Status LED blinks quickly, the device will restore to factory default settings.

- 4 What can I do if I forget the router's Web login User Name and Password?**
In case you changed your router's Login User Name and Password, we suggest you reset your router to factory default settings by above operations.
Then use the following parameters to login the router's Web interface: **Default IP address: 192.168.0.1, User Name: admin, Password: admin.**
- 5 What can I do if I forget my wireless network Password?**
By default, TOTOLINK router don't have any wireless network password.
If you have set one, please enter to router's Web Management page, go to **Wireless --- Basic Settings** to obtain or reset your password.